

## DUAL LOOP CONTROLLER

96 x 96 mm

# RE92



## USER'S MANUAL





# Contents

---

<b>1. INTRODUCTION</b> .....	<b>5</b>
1.1. Purpose .....	5
1.2. Controller properties .....	5
<b>2. CONTROLLER SET</b> .....	<b>6</b>
<b>3. BASIC REQUIREMENTS, OPERATIONAL SAFETY</b> .....	<b>7</b>
<b>4. INSTALLATION</b> .....	<b>7</b>
4.1. Controller installation .....	7
4.2. Electrical connections .....	9
4.3. Recommendations for installation .....	14
<b>5. STARTING WORK</b> .....	<b>15</b>
<b>6. STARTING THE CONTROLLER</b> .....	<b>15</b>
6.1. Information bar .....	15
6.2. Button markings .....	16
6.3. Screen with fixed set-point control .....	16
6.4. Screen with programming control .....	17
6.5. Screen with the timer function .....	17
6.6. Additional screens with values .....	18
6.6.1. Visual alarms .....	19
6.6.2. Rescaling values .....	20
6.7. Change of displayed screens .....	21
6.8. Edit mode .....	23
6.9. Context menu .....	25
<b>7. CONTROLLER CONFIGURATION</b> .....	<b>25</b>
7.1. Menu access password .....	25
7.2. Programming matrix .....	27
7.3. Parameters description .....	28
7.4. Language selection .....	63
<b>8. INPUTS AND OUTPUTS OF THE CONTROLLER</b> .....	<b>64</b>
8.1. Measuring input 1 .....	64
8.2. Measuring input 2 .....	65
8.3. Measuring input 3 .....	65
8.4. Interface inputs 1,2 .....	66
8.5. Binary inputs .....	66
<b>9. CONTROLLER OUTPUTS</b> .....	<b>68</b>
9.1. Controlling outputs .....	68

9.2. Alarm outputs .....	80
9.3. Timer function .....	71
9.4. Retransmission outputs.....	73
9.5. Signal outputs.....	74
<b>10. LOOP CONFIGURATION .....</b>	<b>76</b>
10.1. Controlled signal.....	76
10.2. Control types .....	76
10.3. Control range.....	82
10.4. Set value in loop .....	82
10.5. Control algorithms .....	82
<b>11. PROGRAMMING CONTROL .....</b>	<b>87</b>
11.1. Description of the programming control parameters.....	87
11.2. Defining the set value programs .....	90
<b>12. MODBUS.....</b>	<b>93</b>
12.1. Introduction.....	93
12.2. Archiving configuration.....	93
12.3. Copying archive to SD card.....	94
12.4. Archive file structure.....	95
12.5. Copying archive to SD card.....	98
12.6. Status bar of the archiving.....	99
12.6. Downloading archive files.....	99
<b>13. MODBUS.....</b>	<b>100</b>
13.1. Introduction.....	100
13.2. Modbus master.....	100
13.3. Modbus slave.....	102
13.3.1 Error codes.....	103
13.3.2 Register map.....	103
<b>14. FTP SERVER.....</b>	<b>191</b>
14.1. FTP User.....	191
<b>15. WEB SERVER.....</b>	<b>193</b>
<b>16. SOFTWARE UPGRADE.....</b>	<b>194</b>
<b>17. TECHNICAL DATA.....</b>	<b>194</b>
<b>18. CONTROLLER ORDERING CODE.....</b>	<b>199</b>

*This manual is valid for the controller using software v1.11.11*

# 1. INTRODUCTION

---

## 1.1. Purpose

Two-loop RE92 controller used to control temperature and other physical values (e.g. pressure, humidity, flow level). It can control two objects independently or control two physical values in one object (e.g. two-chamber furnaces).

## 1.2. Controller properties

RE92 controller is characterized by the following features:

- two-loop control and measurement,
- 3,5" TFT full-color screen, resolution: 320 x 240 pixel,
- intuitive handling via six buttons and graphic user interface,
- two universal measuring inputs (for thermoresistors, thermocouples or standard linear signals),
- additional input,
- communication interfaces: RS-485 Modbus Slave, Modbus TCP Slave,
- six binary outputs (possible direct control via the interface),
- two voltage and current analog outputs,
- three binary inputs additional 3 binary inputs controlled from the interface,
- object transducers supply output,
- software upgrade possibility using SD card,
- two-step control, three-step step-by-step control, three-step control of heating-cooling type,
- SMART PID innovative algorithm,
- alarms,
- timers function,
- FTP server,
- three independent groups of data archiving of 10 values in the group.
- Web server (available in controller versions with Ethernet interface),

- modbus master function - querying 2 devices 10 registers each time,
- two interface measurement inputs - readout of measured values from external devices via RS-485 Modbus master,
- possibility to assign custom names to measurement channels.
- extended functions of programming control,
- additional 3 screens with the possibility of displaying up to 18 any values from the controller's modbus registers.

## 2. CONTROLLER SET

---

Complete set of the controller includes:

1. controller .....	1 pc
2. seal.....	1 pc
3. holders to fix the meter in the panel ....	4 pcs
4. plug with 16 screw terminals .....	2 pcs
5. plug with 10 screw terminals .....	2 pcs
6. user manual .....	1 pc
7. guarantee card .....	1 pc

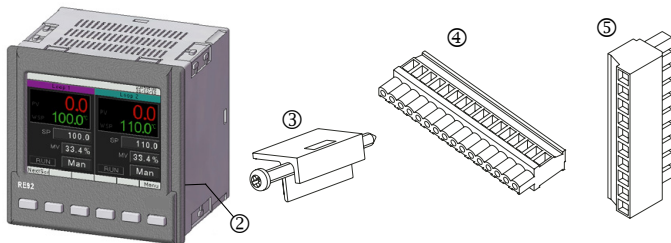

### 3. BASIC REQUIREMENTS, OPERATIONAL SAFETY

---

The controller conforms to a safety standard EN 61010-1.



**Additional comments concerning safety:**

- Assembly and installation of the electrical connections should be conducted only by people authorized to perform assembly of electric devices.
- Always check the state of connections before turning the controller on.
- Prior to taking the controller housing off, always turn the supply off and disconnect measuring circuits.
- Removal of the controller housing during the warranty period voids the warranty.
- The device is designed for installation and usage in the industrial electromagnetic environment.
- A switch or a circuit-breaker should be installed in the building or facility. This switch should be located near the device, easily accessible by the operator, and suitably marked.

### 4. INSTALLATION

---

#### 4.1. Controller installation

Fix the controller to the board with three screw brackets as shown in the fig. 1A slot in the panel must have the following dimensions:  $92.5^{+0.6} \times 92.5^{+0.6}$  mm. The thickness of the panel material cannot exceed 6 mm.

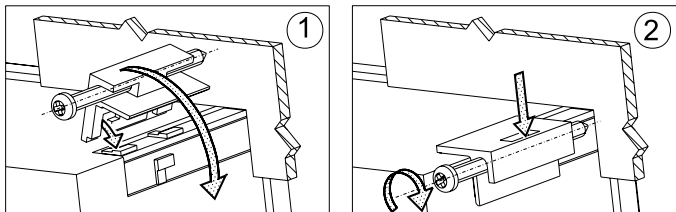

*Fig. 1. Controller installation.*

Dimensions of the controller are presented on the fig. 2.

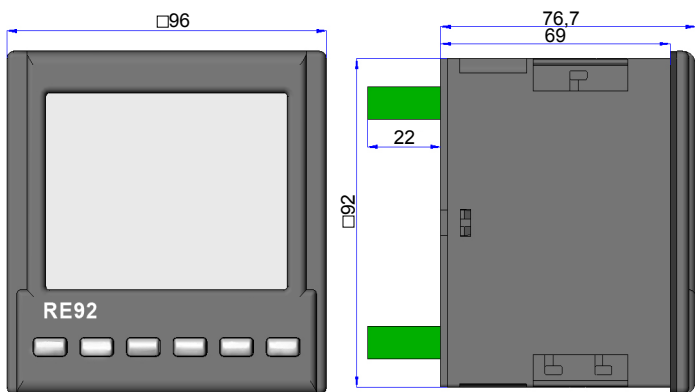

*Fig. 2. Controller dimensions.*



## 4.2. Electrical connections

The controller has three separate strips with screw terminals. Two strips with 16 terminals each allow to connect all signal sources by a wire with a 2.5 mm<sup>2</sup> cross-section, and two strips with 10 terminals each allow for connecting by a wire with 1.5 mm<sup>2</sup> cross-section.

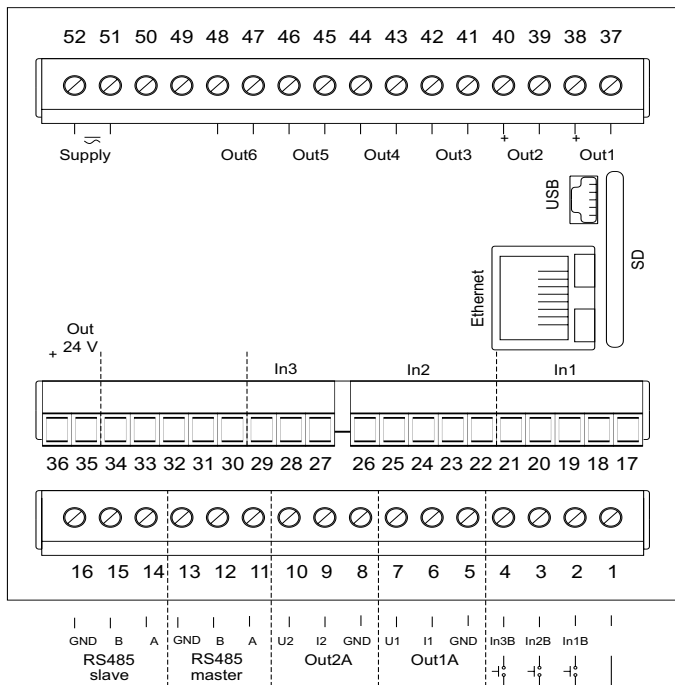

Fig. 3. Connection strips of the controller.

## CONNECTING THE SUPPLY



supply should be connected to the terminals 51 and 52, according to technical data

## CONNECTION OF 1 AND 2 INPUT

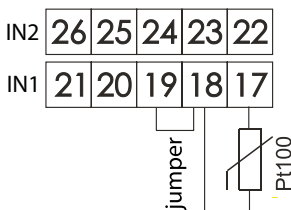

thermoresistor Pt100  
in 2-wire system

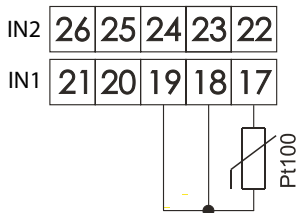

thermoresistor Pt100  
in 3-wire system

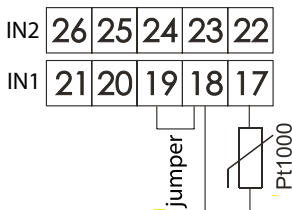

thermoresistor Pt1000

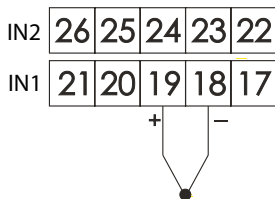

thermocouples

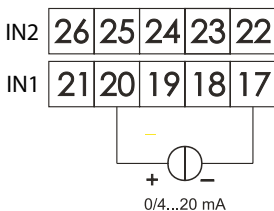

current input  
0/4...20 mA

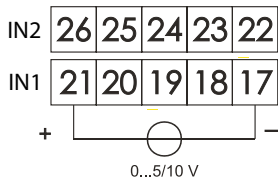

voltage input  
0...5/10 V

### CONNECTION OF INPUT 3

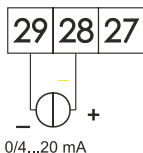

current input  
0/4..20 mA

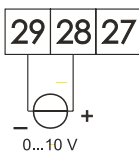

voltage input  
0...5/10 V

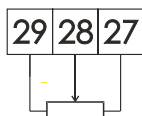

potentiometric  
input

### CONNECTION OF THE BINARY OUTPUTS

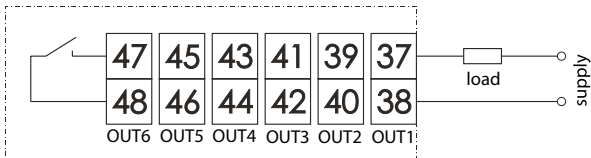

output 1–6 – relay

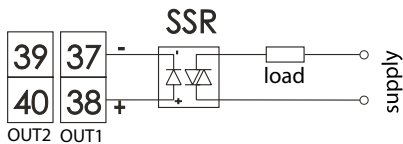

output 1 and 2 – voltage 0/5 V

## CONNECTING THE ANALOG OUTPUTS

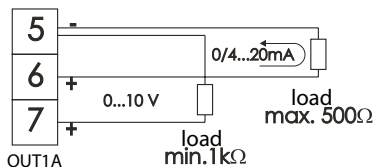

output 1A –  
current 0/4–20 mA  
and voltage 0–10 V

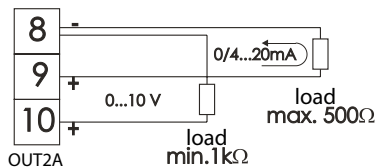

output 2A –  
current 0/4–20 mA  
and voltage 0–10 V

## CONNECTING THE BINARY INPUTS

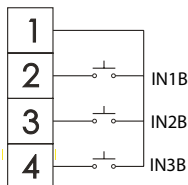

volt-free binary inputs

## CONNECTING THE RS-485 INTERFACE

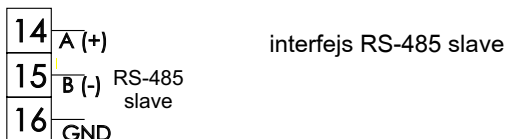

## CONNECTING OBJECT TRANSDUCERS SUPPLY

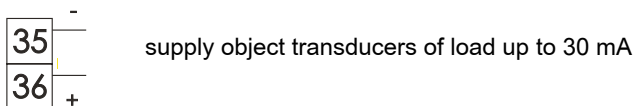

## ETHERNET CONNECTION



For Ethernet connection use the category 5 shielded twisted-pair wire with RJ-45 connector, compliant to the following standards:

- EIA/TIA 568A for both connectors in strike-through connection (i.e. between RE92 and hub or switch),
- EIA/TIA 568A for the first connector and EIA/TIA 568B for the second one in the cross-over connection (i.e. when connecting RE92 to the computer).

### 4.3. Recommendations for installation

To achieve full electromagnetic resistance of the controller, it is necessary to follow the rules described below:

- do not supply the controller from the network in the proximity of devices generating high pulse noises and do not apply common earthing circuits,
- apply network filters,
- wires leading measuring signal should be twisted in pairs and for the resistance sensors in the three-wire connection they should use twisted wires of exactly the same length, cross-section and resistivity protected by shielding,
- all shields should be one-side earthed or connected to the protection wire, the nearest possible to the controller,
- as a rule of thumb, wires transmitting different signals should be spaced as far as it is possible (at least 30 cm) and should be crossed only at the right angle (90 degrees)<sup>o</sup>.
- to connect RE92 controller to the Ethernet it is recommended to use:
  - U/FTP – twisted pair cable with separate foil shielding for every pair,
  - F/FTP – twisted pair cable with separate foil shielding for every pair and additional foil shielding for the cable,
  - S/FTP (former SFTP) – twisted pair cable with separate foil shielding for every pair and additional mesh cable shielding,
  - SF/FTP (former S-STP) – twisted pair cable with separate foil shielding for every pair and additional mesh and foil cable shielding.

## 5. STARTING WORK

---

After turning a supply on, the controller displays logo and then moves to the normal operational mode.

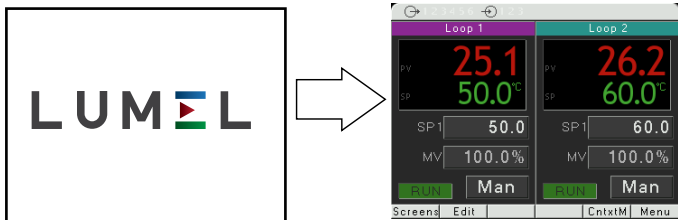

## 6. STARTING THE CONTROLLER

---

### 6.1. Information bar

Information bar displays the state of outputs, binary inputs and real-time clock. When active binary outputs and inputs are displayed in black, inactive ones are displayed in light grey color. State of the outputs, binary inputs and real-time clock can be hidden.

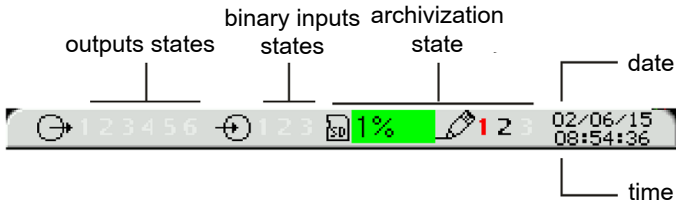

Fig. 4. Information bar

## 6.2. Button markings

Depending on the service location, controller buttons can perform different functions. Functions are described in the bar on the bottom of the screen. If the button lacks description, it is inactive at the moment. Fig. 5 shows an example of the button marking.

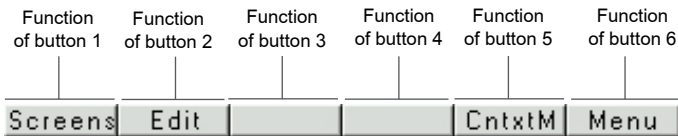

Fig. 5. Buttons marking - example

## 6.3. Screen with fixed set-point control

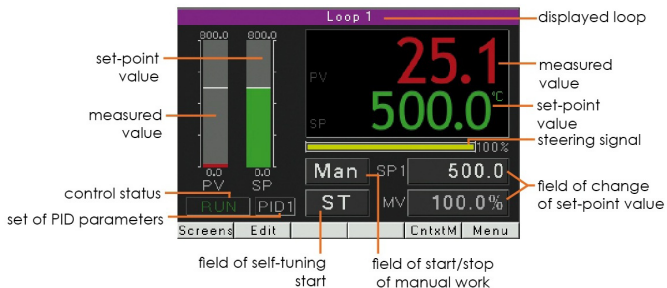

Fig. 6. Screen with fixed set-point control



## 6.4. Screen with programming control

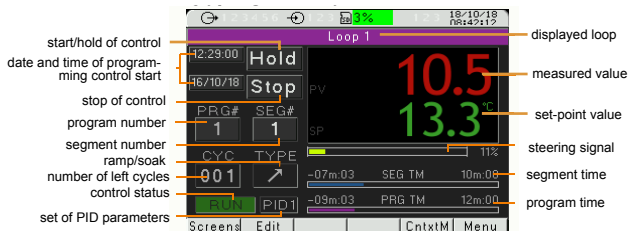

Fig. 7. Screen with programming control

## 6.5. Screens with the Timer function

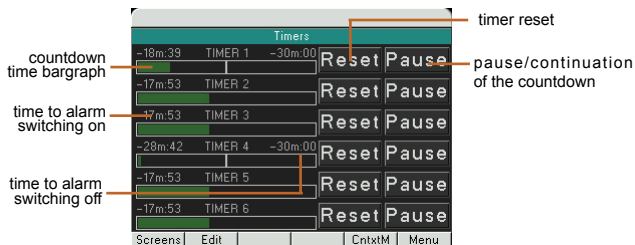

Fig. 8. Alarm Timers screen

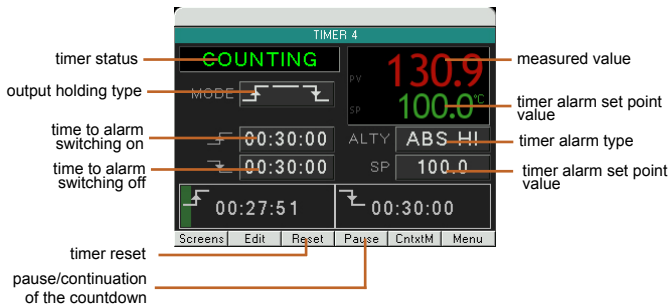

Fig. 9. Single Alarm Timer screen

## 6.6. Additional screens with values

The RE92 controller allows displaying any value from the available modbus registers of the controller. These values can be displayed on 3 additional screens of the controller, in the configuration from 1 to 6 displayed values on the screen. For each value it is possible to configure:

- its name (up to 12 characters),
- units from the unit table or entering your own name for the unit (up to 6 characters),
- color in which the value on the screen is to be displayed,
- display precision,
- rescaling values with individual characteristics,
- visual alarm (alarm type, alarm color, alarm signaling after its discontinuation).

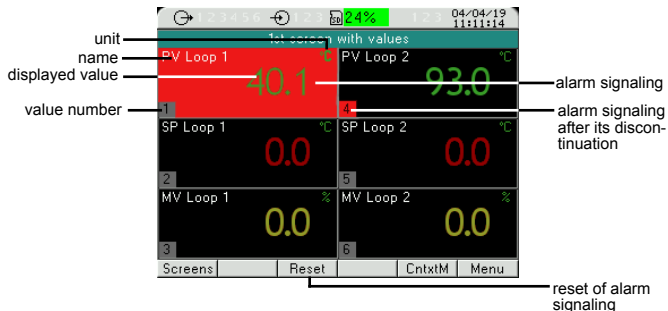

Fig. 10. An example of an additional screen with values

## 6.6.1. Visual alarms

For each value on the screen, you can assign a visualization alarm. The alarm function is only used for visual signaling of exceeded values displayed and is not related to any controller output.

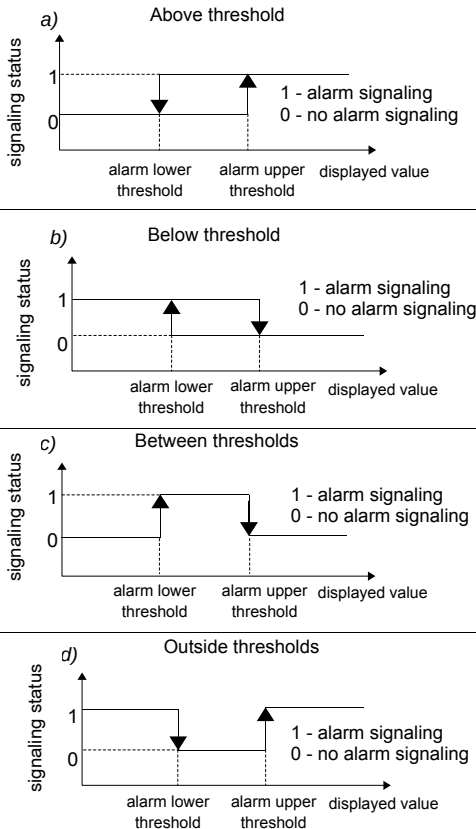

Fig. 11. Alarm types

Other alarm types:

- Manually switched on - continuous alarm signaling (alarm permanently enabled)
- Manually switched off - no alarm signaling (alarm permanently disabled)

When the alarm signaling function after its discontinuation is switched on, then after the alarm state has disappeared, the indicator signaling such a state lights up.

After the alarm discontinuation the alarm signaling indicator is active until it is reset by means of the Reset button.

## 6.6.2. Rescaling values

Based on the coordinates of two points given by the user, the controller determines (from the system of equations) the individual characteristics coefficients **a** and **b**.

Lower output value =  $a * \text{Lower input value} + b$

Upper output value =  $a * \text{Upper input value} + b$

where:

Lower input value, Upper input value - values read from registers

Lower output value, Upper output value - expected values on the display

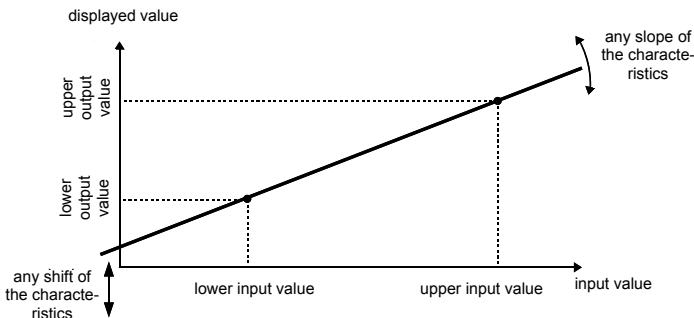
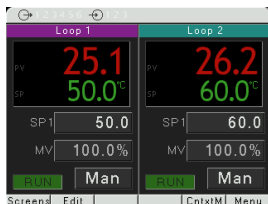

Fig. 12. Rescaling the displayed value

## 6.7. Changing the display screens

Pressing the **Screens** button, you can switch between the views of selected screens. The choice of screens to be displayed is made in the Settings -> Show screens. Figure 13 shows an example of a change in display screens for the regulator with the programming control.



↓ Button **Screens**

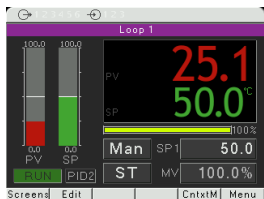

→  
via Context  
Menu

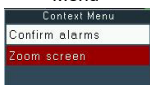

↓ Button **Screens**

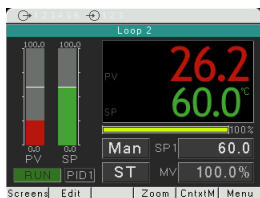

→  
via Context  
Menu

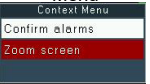

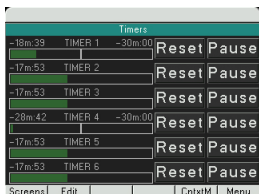

via Context Menu



Button Screens

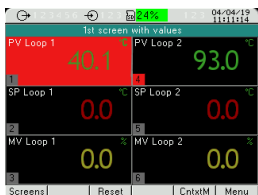
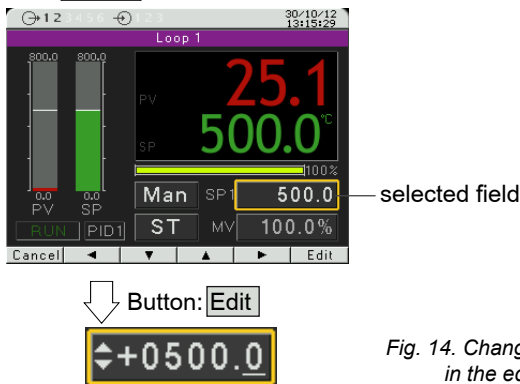

Fig. 13. Change of the displayed screens - example

## 6.8. Edit mode

### *Changing the value in the edit field.*

To change the value in the edit field (i.e. set value), press the **Edit** button, the first field of the list will be highlighted in yellow. Then use the **◀**, **▼**, **▲**, **▶** buttons to select the edit field for change. After pressing the **Edit** button, use **◀**, **▶** buttons to change the number position; **▼**, **▲** increase or decrease the value of the selected number. The change must be accepted with the **OK** button or cancelled with the **Cancel** button.



*Fig. 14. Changing the value in the edit field.*

## Using the button type field.

To use such field (e.g. start/stop control), press the **Edit** button; the first item in the list will be highlighted in yellow. Then use the **◀**, **▼**, **▲**, **▶** buttons to select the button type field. Pressing the **Exec** button performs a function appropriate to the given button.

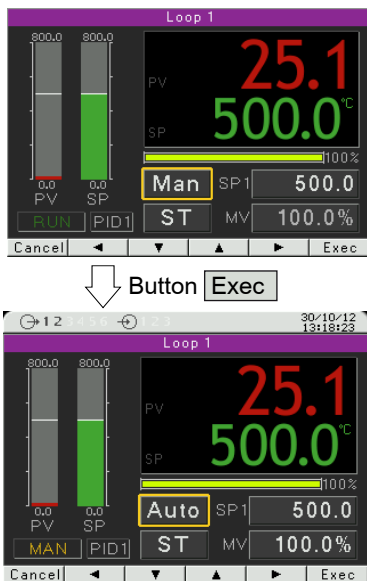

Fig. 15. Using the button type field.



## 6.9. Context menu

Pressing the **ContxtM** button displays the context menu. This menu allows for quick access to a given feature.

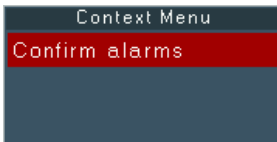

Fig. 16. Context menu

## 7. CONTROLLER CONFIGURATION

---

### 7.1. Menu access password

To switch to the controller configuration from the screen display level, choose the **Menu** button. Use selection and access password window will appear. On the first run, there is only one user *[Admin]* with no set password. It is possible to create four users with different access rights. User *[Admin]* has all the rights, and can set them for the other users. User privileges are selected from the menu: Security → User → Level. *[Level 0]* allows for changing all parameters, including the **[Security]**, *[Level 1]* allows to change all parameters with the exception of the **[Security]** submenu, *[Level 2]* allows for changing the set values, current program, date and time.

In case the user forgets the password, it is possible to delete it. In this case, when the power supply of the controller is off, turn on the power while holding down the two central buttons and wait until the display shows a message informing that the controller factory settings have been restored.

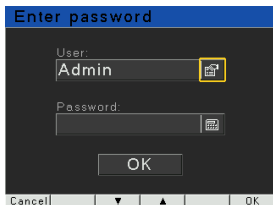

Button

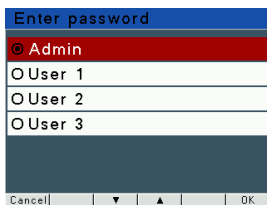

Button

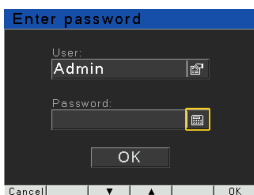

Button

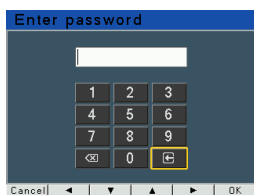

Button

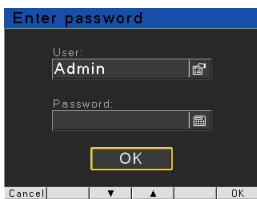

Button



**MENU**

## 7.2. Programming matrix

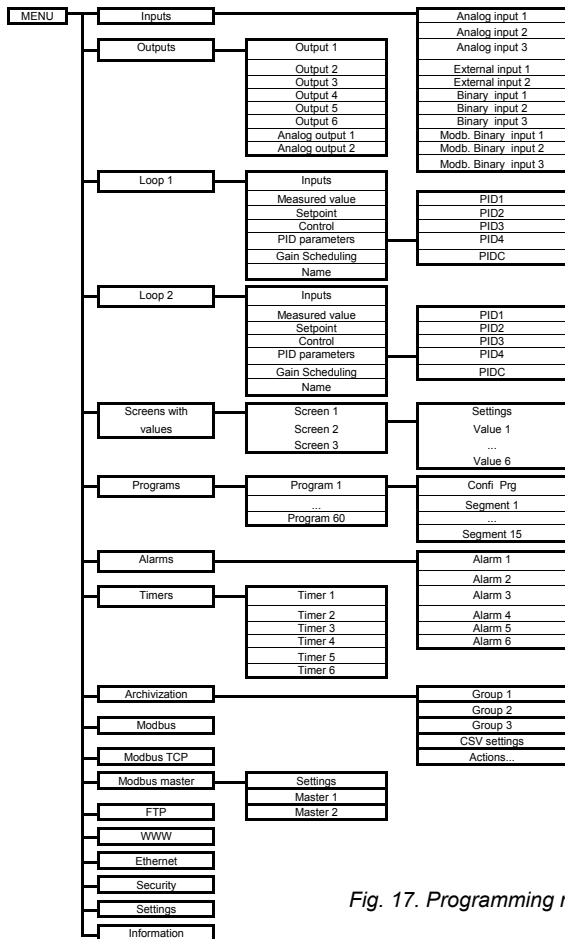

Fig. 17. Programming matrix

## 7.3. Parameters description

The list of parameters is presented in the table 1.

Lista parametrów konfiguracji

Table 1

Symbol of parameter	Parameter name	Factory setting	Parameter modification range	
			sensors	linear input
Inputs				
Analog input 1				
	Input type	Pt100	Pt100 : thermoresistor Pt100 Pt500 : thermoresistor Pt500 Pt1000: thermoresistor Pt1000 Ni100 : thermoresistor Ni100 Ni1000: thermoresistor Ni1000 Cu100 : thermoresistor Cu100 Tc J : J type thermocouple Tc T : T type thermocouple Tc K : K type thermocouple Tc S : S type thermocouple Tc R : R type thermocouple Tc B : B type thermocouple Tc E : E type thermocouple Tc N : N type thermocouple Tc L : L type thermocouple 0..20mA: linear current 0-20mA 4..20mA: linear current 4-20mA 0..5V : linear voltage 0-5 V 0..10V : linear voltage 0-10 V	

		Unit	°C	°C : degrees Celsius °F : degrees Fahrenheit PU: physical units %: percent %RH: relative humidity	
		Dot.level	DP1	DP0 : without a decimal place DP1 : 1 decimal place	DP0 : without a decimal place DP1 : 1 decimal place DP2 : 2 decimal places
		Compensation	Auto	Auto Manual	
		Comp. temp.	0°C	0...50°C	-
		MinInpAnalog	0	-	-9999...99999
		MaxInpAnalog	100	-	-9999...99999
		Correction	0	-35.00...35.00	
		Filter	0.2	Off: filter off 0.2: time constant 0.2 s 0.5: time constant 0.5 s 1: time constant 1 s 2: time constant 2 s 5: time constant 5 s 10: time constant 10 s 20: time constant 20 s 50: time constant 50 s 100: time constant 100 s	
Analog input 2					
		as per analog input 1			

Analog input 3				
		Input type <sup>1)</sup>	4..20mA 0..10V R100	0..20mA: linear current 0-20mA 4..20mA: linear current 4-20mA 0..5V: linear voltage 0-5 V 0..10V: linear voltage 0-10 V R100: potentiometric input 100 Ohm R1000: potentiometric input 1000 Ohm
		Unit	°C	°C : degrees Celsius °F : degrees Farenheit PU: physical units %: percent %RH: relative humidity
		Digit Point	DP1	DP0 : without a decimal place DP1 : 1 decimal place DP2 : 2 decimal places
		LowScale	0	-9999...99999
		HighScale	100	-9999...99999
		Shift	0	-35.00...35.00
		Filter	0.2	Off: filter off 0.2: time constant 0.2 s 0.5: time constant 0.5 s 1: time constant 1 s 2: time constant 2 s 5: time constant 5 s 10: time constant 10 s 20: time constant 20 s 50: time constant 50 s 100: time constant 100 s
Modbus input 1, Modbus input 2				
		Assignment	Master 1	Master 1: modbus master 1 Master 2: modbus master 2
		Registry name	0	List of 10 registers or their names read by the modbus master function

		Unit	°C	°C : degrees Celsius °F : degrees Fahrenheit PU: physical units %: percentage %RH: relative humidity
		Digit Point	DP1	DP0 : no decimal place DP1 : 1 decimal place DP2 : 2 decimal places
		Shift	0.0	-35.00...35.00
		Filter	0.2	Off: filter off 0.2: time constant 0.2 s 0.5: time constant 0.5 s 1: time constant 1 s 2: time constant 2 s 5: time constant 5 s 10: time constant 10 s 20: time constant 20 s 50: time constant 50 s 100: time constant 100 s
Binary input 1				
		Function	none	none: none Stop: stop automatic control (response to a level) ManualOp: switching to manual operation (response to a level) SP+1: switching to subse quent SP (response to a level) SP1<->SP2, SP2<->SP3, SP3<->SP4, SP4<->SP1 StartPrg: program start (response to the rising edge) NextSegment: jump to the next segment (response to the rising edge) PrgBlock: stop the incrementing of the set point in the program (response to a level)

				<p>PrgEnd: end of the program (response to the rising edge)</p> <p>PrgStop: stop of the program with possible continuation (response to the rising edge)</p> <p>PrgStopBeg: stop the program and jump to the beginning (response to the rising edge)</p> <p>SP-IN3: switching to subsequent SP from the additional input (response to a level)</p> <p>Reset timer1: alarm reset of timer 1</p> <p>Reset timer2: alarm reset of timer 2</p> <p>Reset timer3: alarm reset of timer 3</p> <p>Reset timer4: alarm reset of timer 4</p> <p>Reset timer5: alarm reset of timer 5</p> <p>Reset timer6: alarm reset of timer 6 (response to a level)</p> <p>SP-IN1: switching to SP from the first input (response to a level)</p> <p>SP-IN2: switching to SP from the second input (response to a level)</p> <p>SP - Modbus IN1: switching to SP from the first interface input</p> <p>SP - Modbus IN2: switching to SP from the second interface input (response to a level)</p> <p>SP-Cyclic: switching to subsequent SP (response to the rising edge) SP1&gt;&gt;SP2&gt;&gt;SP3&gt;&gt;SP4 &gt;&gt;SPIN1&gt;&gt;SPIN2&gt;&gt;SPIN3 &gt;&gt;SPMd1&gt;&gt;SPMd2&gt;&gt;SP1</p> <p>Out Min/Max 2: switching to the second set of parameters for limiting the control signal (response to a level)</p>
--	--	--	--	--



Binary input 2				
		as per binary input 1		
Binary input 3				
		as per binary input 1		
Modbus binary input 1				
		as per Binary input 1		(Binary input function entered into register 7590)
Modbus binary input 2				
		as per Binary input 1		(Binary input function entered into register 7592)
Modbus binary input 3				
		as per Binary input 1		(Binary input function entered into register 7594)
Outputs				
Output 1				
		Assignment	None	<p>None: none</p> <p>Loop 1: loop 1</p> <p>Loop 2: loop 2</p> <p>Input 1: input 1</p> <p>Input 2: input 2</p> <p>Input 3: input 3</p> <p>INP1+2+3: input 1 + input 2 + input 3</p> <p>BinInp1: binary input 1</p> <p>BinInp2: binary input 2</p> <p>BinInp3: binary input 3</p> <p>InvBinInp1: inverted binary input 1</p> <p>InvBinInp2: inverted binary input 2</p> <p>InvBinInp3: inverted binary input 3</p> <p>Modbus In1: interface input 1</p> <p>Modbus In2: interface input 2</p> <p>ModbEvIn1: interface binary input 1 (register 4055)</p>

			<p>ModbEvIn2 – interface binary input 2 (register 4056)</p> <p>ModbEvIn3 – interface binary input 3 (register 4057)</p> <p>ModbEvIn1Neg: inverted interface binary input 1 (register 4055)</p> <p>ModbEvIn2Neg: inverted interface binary input 2 (register 4056)</p> <p>ModbEvIn3Neg: inverted interface binary input 3 (register 4057)</p> <p>ModbReg: control from interface (register 4058)</p> <p>ModbReg Neg: inverted control from interface (register 4058)</p>
	Function	None	<p>None: none</p> <p>Heating: heating</p> <p>Cooling: cooling</p> <p>Opening: valve opening</p> <p>Closing: valve closing</p> <p>Alarm: alarm</p> <p>Event Prg: progr. control event</p> <p>CascadeSlv: signal of the slave loop with cascade control</p> <p>Timer: alarm timera</p> <p><b>Caution!</b> When the heating-cooling function is selected, please keep in mind that it should be consistent with the type of control selected in the channel, which the output is assigned to.</p>

		Prg Event	None	None: none Occ.1.Sec: event 1 from a section Occ.2.Seg: event 2 from a section Occ.3.Sec: event 3 from a section Occ.4.Sec: event 4 from a section Occ.5.Sec: event 5 from a section Occ.6.Sec: event 6 from a section Prg.Block.: deviation block
		Output type	-	None: none Transmitter: relay output SSR: SSR output
		Cycle Time	20.0	0.5...99.0
Output 2				
		Assignment	None	As per Output 1, except for: ModbReg: control from interface (register 4059) ModbReg Neg: inverted control from interface (register 4059)
		Function	None	As per Output 1
		Prg. Event	None	
		Output Type	-	
		Cycle Time	20.0	
Output 3				
		Assignment	None	As per Output 1, except for: ModbReg: control from interface (register 4060) ModbReg Neg: inverted control from interface (register 4060)
		Function	None	As per Output 1
		Prg. Event	None	
		Output Type	-	
		Cycle Time	20.0	

Output 4				
		Assignment	None	As per Output 1, except for: ModbReg: control from interface (register 4061) ModbReg Neg: inverted control from interface (register 4061)
		Function	None	As per Output 1
		Prg. Event	None	
		Output Type	-	
		Cycle Time	20.0	
Output 5				
		Assignment	None	As per Output 1, except for: ModbReg: control from interface (register 4062) ModbReg Neg: inverted control from interface (register 4062)
		Function	None	As per Output 1
		Prg. Event	None	
		Output Type	-	
		Cycle Time	20.0	
Output 6				
		Assignment	None	As per Output 1, except for: ModbReg: control from interface (register 4063) ModbReg Neg: inverted control from interface (register 4063)
		Function	None	As per Output 1
		Prg. Event	None	
		Output Type	-	
		Cycle Time	20.0	

Analog output 1				
		Assignment	None	None: none Loop 1: loop 1 Loop 2: loop 2 Input 1: input 1 Input 2: input 2 Input 3: input 3 INP1+2+3: input 1 + input 2 + input 3 Modbus In1: interface input 1 Modbus In2: interface input 2
		Function	None	None: none Heating: heating Cooling: cooling Retransmission: retransmission <b>Caution!</b> When the heating-cooling function is selected, please keep in mind that it should be consistent with the type of control selected in the channel, which the output is assigned to.
		Retr. source	PV	PV: measuring value SP: set value Deviation: set value - measuring value
		Retr Min	0	-9999...99999
		Retr Max	100.0	-9999...99999
		Ouput type I	4-20 mA	4-20mA: current 4...20 mA 0-20mA: current 0...20 mA
		Ouput type U	0-10V	0-10V: voltage 0...10 V
Analog output 2				
		as per analog output 1		

Loop 1				
Inputs				
		Measuring value		Inp1: input 1 Inp2: input 2 Inp3: input 3 Inp1+Inp2: input 1 + input 2 Inp1+Inp3: input 1 + input 3 Inp2+Inp3: input 2 + input 3 Modbus In1: interface input 1 Modbus In2: interface input 2
		Factor In1	1	-10.00...10.00
		Factor In2	1	-10.00...10.00
		Factor In3	1	-10.00...10.00
		Binary Inputs		None: none EvIn1: binary input 1 EvIn2: binary input 2 EvIn3: binary input 3 EvIn1,2: binary input 1 and 2 EvIn1,3: binary input 1 and 3 EvIn2,3: binary input 2 and 3 EvIn1,2,3: binary input 1, 2 and 3 ModbEvIn1: interface binary input 1 ModbEvIn2: interface binary input 2 ModbEvIn3: interface binary input 3 ModbEvIn1,2: interface binary input 1 and 2 ModbEvIn1,3: interface binary input 1 and 3 ModbEvIn2,3: interface binary input 2 and 3 ModbEvIn1,2,3: interface binary input 1, 2 and 3

Setpoint				
		SP type	SP1	SP1: SP1 set point value SP2: SP2 set point value SP3: SP3 set point value SP4: SP4 set point value IN3: set point value from input 3 PRG: set point value from program IN1: set point value from input 1 IN2: set point value from input 2 Modbus In1: interface input 1 Modbus In2: interface input 2
		Prg Number	Prg01	Prg01: program no 1 Prg02: program no 2 Prg03: program no 3 Prg04: program no 4 Prg05: program no 5 Prg06: program no 6 Prg07: program no 7 Prg08: program no 8 Prg09: program no 9 Prg10: program no 10 Prg11: program number 11 Prg12: program number 12 Prg13: program number 13 Prg14: program number 14 Prg15: program number 15 Prg16: program number 16 Prg17: program number 17 Prg18: program number 18 Prg19: program number 19 Prg20: program number 20 Prg21: program number 21 Prg22: program number 22 Prg23: program number 23 Prg24: program number 24 Prg25: program number 25 Prg26: program number 26 Prg27: program number 27 Prg28: program number 28 Prg29: program number 29 Prg30: program number 30 (for loop 2: Prg31–Prg60)

		SP1	0	-9999...99999
		SP2	0	-9999...99999
		SP3	0	-9999...99999
		SP4	0	-9999...99999
		SP Lo Limit	-199.0	-9999...99999
		SP Hi Limit	999.0	-9999...99999
		Ramp Mode	Off	Off: off rate/min: accrual in units / minute rate/h: accrual in units / hour
		Ramp rate	0	-9999...99999
		PRG start at time	No	No - No permission to start the programming control at a given time Yes - Permission to start the programming control at a given time
		Date of PRG start	01/01/2015	Date of programming control start at a given time
		Time of PRG start	00:00:00	Time of programming control start at a given time
<b>Control</b>				
		Control type	Heat	Off: control off Heat: heating-type control Cool: cooling-type control Heat-Cool: heating-cooling control Valve: step-by-step valve control Valve Fdb.: step-by-step feedback valve control <b>Caution!</b> When the heating-cooling function is selected, please keep in mind that it should be consistent with the type of control selected in the channel, which the output is assigned to.



		Control Alg	PID	On-Off: on-off algorithm PID: PID algorithm
		Hysteresis	2.0	0.1...100.0
		Dead Band	0.0	-99.9...99.9
		Valve Open Time	30 s	3...600 s
		Valve Close Time	30 s	3...600 s
		Min Work Time	0.1 s	0.1...99.0 s
		Out Min	0.00%	0.0...100.0 %
		Out max	100.00%	0.0...100.0 %
		Out Min 2	0.00%	0.0...100.0 %
		Out max 2	100.00%	0.0...100.0 %
		Out Fail	0	-100.0...100.0
		Ctrl Lim Lo	0	-9999...99999
		Ctrl Lim Hi	800.0	-9999...99999
<b>PID Parameters</b>				
<b>PID 1</b>				
		Pb	30.0 °C	0.1...550.0 °C (0.1...990.0 °F)
		Ti	300 s	0...9999 s
		Td	60.0 s	0.0...2500.0 s
		Y0	0.00%	0...100.0 %
<b>PID 2</b>				
<b>PID 3</b>				
<b>PID 4</b>				
		as per PID1		

PID C				
		Pb	100.00%	0.1...200.0 %
		Ti	300 s	0...9999 s
		Td	60.0 s	0.0...2500.0 s
Gain Scheduling				
		GS Type	Off	Off: off SP: switched according to set value Set: fixed set
		GS level nb.	2	2: 2 PID sets used 3: 3 PID sets used 4: 4 PID sets used
		GS Level 1-2	0	-9999...99999
		GS Level 2-3	0	-9999...99999
		GS Level 3-4	0	-9999...99999
		GS Set	PID1	PID1: PID1 set PID2: PID2 set PID3: PID3 set PID4: PID4 set
Name				
		Name		Loop proper name - 10 characters
Loop 2				
		as per loop 1 and additional:		
Setpoint				
		Casc. SP Lo	0.0	-9999...99999
		Casc. SP Hi	100.0	-9999...99999

Control				
		Control Type	Heat	Off: control off Heat : heating-type control Cool : cooling-type control Heat-Cool: heating-cooling control Valve: step-by-step valve control Valve Fdb: step-by-step feedback valve control Cascade: Cascade control <b>Caution!</b> When the heating-cooling function is selected, please keep in mind that it should be consistent with the type of control selected in the channel, which the output is assigned to.
Screens with values				
		Screen 1		
		Settings		
		Show values	6/6	<ul style="list-style-type: none"> <li>● Value 1</li> <li>● Value 2</li> <li>● Value 3</li> <li>● Value 4</li> <li>● Value 5</li> <li>● Value 6</li> </ul>
		Value 1		
		Value name	PV Loop 1	12 ASCII characters from the range 0x20 ... 0x7A
		Value color	green	Green, Red, Yellow, White, Blue, Purple
		Unit selection	From the table	From the table - unit selected from the set, „Unit” parameter, Manual entry - unit entered manually, „Unit name” parameter
		Unit	°C	°C, °F, PU, %, %RH, g/m <sup>3</sup> , g/kg, kJ/kg, at, Pa, hPa, kPa, MPa, mmHg, bar, cmHg, inHg, kp/cm <sup>2</sup> , m <sup>2</sup> , m <sup>3</sup> , ug/m <sup>3</sup>

		Unit name		6 ASCII characters from the range 0x20 ... 0x7A
		Register number	7006	Modbus register number of the controller
		Digit Point	DP1	DP0 : no decimal place DP1 : 1 decimal place DP2 : 2 decimal places DP3 : 3 decimal places DP4 : 4 decimal places
		Alarm type	Hand Off	Above treshold Below treshold Between tresholds Beyond tresholds Hand On Hand Off (Alarm description in Fig. 11)
		Lower alarm Treshold	0.0	-999999.9...999999.9
		Upper alarm Treshold	100.0	-999999.9...999999.9
		Alarm sygnaling delay	0 s	0...3600 s The parameter is defined in seconds. Defines the time to elapse from the time of alarm occurrence to the time when alarm is signaled on the screen. The alarm signaling is switched off without delay
		Uphold alarm signaling	Off	Off : Upholding the signaling after the alarm disontunuation off On : Upholding the signaling after the alarm disontunuation on
		Sygnaling of alarm		Continuous Flashing

		Color below threshold	Green	Black, Green, Red, Yellow, White, Blue, Purple
		Color above threshold	Red	Black, Green, Red, Yellow, White, Blue, Purple
		Value rescaling	Off	Off : Rescaling values off On : Rescaling values on
		Lower input value	0.0	Lower input value -9999.9...9999.9
		Lower output value	0.0	Lower output value -999999.9...999999.9
		Upper input value	0.0	Upper input value -9999.9...9999.9
		Upper output value	0.0	Upper output value -999999.9...999999
		Value 2		
		like Screen 1, Value 1 except		
		Value name	SPLoop 1	
		Value color	Red	
		Register number	7008	
		Value 3		
		like Screen 1, Value 1 except		
		Value name	MVLoop 1	
		Value color	Yellow	
		Unit	%	
		Register number	7010	

		Value 4	
		like Screen 1, Value 1 except	
		Value name	PV Loop 2
		Register number	7014
		Value 5	
		like Screen 1, Value 1 except	
		Value name	SP Loop 2
		Value color	Red
		Register number	7010
		Value 6	
		like Screen 1, Value 1 except	
		Value name	MV Loop 2
		Value color	Yellow
		Unit	%
		Register number	7018
		Screen 2	
		Settings	
		Show values	3/6 <ul style="list-style-type: none"> <li>● Value 1</li> <li>● Value 2</li> <li>● Value 3</li> <li>○ Value 4</li> <li>○ Value 5</li> <li>○ Value 6</li> </ul>
		Value 1	
		like Screen 1, Value 1 except	
		Value name	PV Input 1
			12 ASCII characters from the range 0x20 ... 0x7A
		Register number	7000
			Modbus register number of the controller

		Value 2	
		like Screen 1, Value 1 except	
		Value name	PV Input 2
		Register number	7002
		Value 3	
		like Screen 1, Value 1 except	
		Value name	PV Input 3
		Register number	7004
		Value 4	
		like Screen 1, Value 1 except	
		Value name	Year
		Value color	White
		Unit selection	Manual entry
		Unit name	
		Register number	4012
		Digit Point	DP0
		Value 5	
		like Screen 1, Value 1 except	
		Value name	Month Day
		Value color	White
		Unit selection	Manual entry
		Unit name	MM/DD
		Register number	4011
		Digit Point	DP0

		Value 6	
		like Screen 1, Value 1 except	
		Value name	Hour
		Value color	blue
		Unit selection	Manual entry
		Unit name	hh:mm
		Register number	4009
		Digit Point	DP0
		Screen 3	
		Settings	
		Show values	6/6 <ul style="list-style-type: none"> <li>● Value 1</li> <li>● Value 2</li> <li>● Value 3</li> <li>● Value 4</li> <li>● Value 5</li> <li>● Value 6</li> </ul>
		Value 1...6	
		like Screen 1, Value 1 except	
		Value color	blue
		Unit selection	Manual entry
		Unit name	
		Register number	0 Entering register number of 0 disables the display of values on the screen. This is indicated by the inscription „Off“



Programs				
Program 1				
Config Prg				
		Start Prg	Start PV	Start SP Start PV
		Start SP	0	-9999...99999
		Time Unit	mm:ss	mm:ss hh:mm
		Ramp Unit	Min	Min Hour
		Holdback Type	Disable	Disable Low High Band
		Cycles Number	1	1...9999
		Power Fail	Continue	Continue Stop
		End type	Stop	Stop Last SP
		Gain scheduling	Off	Off On
Segment 1				
		Seg.type	Time	Time Accrual Hold End
		Target SP	0	-9999...99999
		Seg. duration	00:00	00:00... 99:59
		Ramp rate	0.1	0.1...999.9
		Holdback Val	0	-9999...99999

		Event1	Off	Off On
		Event2	Off	Off On
		Event3	Off	Off On
		Event4	Off	Off On
		Event5	Off	Off On
		Event6	Off	Off On
		PID set	PID1	PID1 PID2 PID3 PID4
Segment 2				
...				
Segment 15				
		as Segment 1		
Program 2				
...				
Program 60				
		as Program 1		
Alarms				
Alarm 1				
		Type	AbsHigh	AbsHigh: absolute upper AbsLo: absolute lower DevHigh: relative upper DevLo.: relative lower DevInBand: relative internal DevOutBand: relative external

		SP	100	-9999...99999
		Deviation	0	-9999...99999
		Hysteresis	2	0.1...99.9
		Latch	Off	Off: off On: on
		Overflow state	Off	Off: off On: on
Alarm 2				
...				
Alarm 6				
		as Alarm 1		
Timers				
Timer 1				
		Function	Off	Off: alarm timer disabled On: alarm timer enabled
		Time	00:30:00	00:00:01...23:59:59
		Uphold output	Continuous	Continuous: continuous output latch Time: to latch the output for a certain time
		Uphold time	00:30:00	00:00:01...23:59:59 (active if Uphold output: Time)
		Type	AbsHigh	AbsHigh: absolute upper AbsLo: absolute lower (active if Output → Assignment: Input 1 or Input 2 or Input 3 or INP1+2+3)
		SP	100,0	-9999...99999 (active if Output → Assignment: Input 1 or Input 2 or Input 3 or INP1+2+3)

Timer 2				
...				
Timer 6				
		as Timer 1		
Archiving				
Group 1				
		Arch. on/off	off	off: archiving disabled on: archiving enabled
		Parameters	PV_Input1 PV_Input2 PV_Input3	PV_Input1: measured value from input 1 PV_Input2: measured value from input 2 PV_Input3: measured value from input 3 PV_Loop1: measured value in loop 1 SP_Loop1: setpoint value for loop 1 CTRL1_Loop1: control loop 1 control signal in loop 1 CTRL2_Loop1: control loop 2 control signal in loop 1 PV_Loop2: measured value in loop 2 SP_Loop2: setpoint value for loop 2 CTRL1_Loop2: control loop 1 control signal in loop 2 CTRL2_Loop2: control loop 2 control signal in loop 2 Modbus Input1: interface input 1 Modbus Input2: interface input 2 Master 1 Reg2: register 2 readout from master 1 Master 1 Reg3: register 3 readout. from master 1 Master 1 Reg4: register 4 readout. from master 1 Master 1 Reg5: register 5 readout. from master 1 Master 1 Reg6: register 6 readout. from master 1 Master 1 Reg7: register 7 readout. from master 1 Master 1 Reg8: register 8 readout. from master 1

			<p>Master 1 Reg9: register 9 readout. from master 1</p> <p>Master 1 Reg10: register 10 readout. from master 2</p> <p>Master 2 Reg1: register 1 readout. from master 2</p> <p>Master 2 Reg2: register 2 readout. from master 2</p> <p>Master 2 Reg3: register 3 readout. from master 2</p> <p>Master 2 Reg4: register 4 readout. from master 2</p> <p>Master 2 Reg5: register 5 readout. from master 2</p> <p>Master 2 Reg6: register 6 readout. from master 2</p> <p>Master 2 Reg7: register 7 readout. from master 2</p> <p>Master 2 Reg8: register 8 readout. from master 2</p> <p>Master 2 Reg9: register 9 readout. from master 2</p> <p>Master 2 Reg10: register 10 readout. from master 2</p>
	Archiv type	Interval	<p>Interval: archiving at specified time interval</p> <p>AbsHigh: at a interval after exceeding the upper threshold set by SP Abs</p> <p>AbsLo.: at a interval after exceeding the lower threshold set by SP Abs</p> <p>DevHigh: at a interval after exceeding the relative upper threshold</p> <p>DevLo.: at a interval after exceeding the relative lower threshold</p> <p>DevInBand: at a interval inside the limits of relative</p> <p>DevOutBand: at a interval outside the limits of relative</p>



				<p>Master2 Reg2: register 2 readout from master 2</p> <p>Master2 Reg3: register 3 readout from master 2</p> <p>Master2 Reg4: register 4 readout from master 2</p> <p>Master2 Reg5: register 5 readout from master 2</p> <p>Master2 Reg6: register 6 readout from master 2</p> <p>Master2 Reg7: register 7 readout from master 2</p> <p>Master2 Reg8: register 8 readout from master 2</p> <p>Master2 Reg10: register 10 readout from master 2 (parameter active when Archiv type different from Interval)</p>
		Interval	00:00:30	00:00:05...24:00:00
		SP Abs	100.0	-9999...99999 (parameter active, when Archiv type AbsHigh, AbsLo)
		SP Dev	SP_loop 1	<p>PV_Input1: measured value from input 1</p> <p>PV_Input2: measured value from input 2</p> <p>PV_Input3: measured value from input 3</p> <p>PV_Loop1: measured value in loop 1</p> <p>SP_Loop 1: setpoint value for loop 1</p> <p>CTRL1_Loop1: control signal path 1 from loop 1</p> <p>CTRL2_Loop1: control signal path 2 from loop 1</p> <p>PV_Loop2: measured value in loop 2</p> <p>SP_Loop2: setpoint value for loop 2</p> <p>CTRL1_Loop2: control signal path 1 from loop 2</p> <p>CTRL2_Loop2: control signal path 2 from loop 2</p> <p>Modbus Input1: interface input 1</p> <p>Modbus Input2: interface input 2</p>

					Master1 Reg1: register 1 readout from master 1
					Master 1 Reg2: register 2 readout from master 1
					Master1 Reg3: register 3 readout from master 1
					Master1 Reg4: register 4 readout from master 1
					Master1 Reg5: register 5 readout from master 1
					Master1 Reg6: register 6 readout from master 1
					Master1 Reg7: register 7 readout from master 1
					Master1 Reg8: register 8 readout from master 1
					Master1 Reg9: register 9 readout from master 1
					Master1 Reg10: register 10 readout from master 2
					Master2 Reg1: register 1 readout from master 2
					Master2 Reg9: register 9 readout from master 2
					Master2 Reg3: register 3 readout from master 2
					Master2 Reg4: register 4 readout from master 2
					Master2 Reg5: register 5 readout from master 2
					Master2 Reg6: register 6 readout from master 2
					Master2 Reg7: register 7 readout from master 2
					Master2 Reg8: register 8 readout from master 2
					Master2 Reg10: register 10 readout from master 2 (parameter active, when Archive type AbsHigh, AbsLo, DevInBand, DevOut- Band)



		Deviation	2.0	-9999...99999 (parameter active, when the Archive type AbsHigh, AbsLo, DevInBand, DevOut-Band)
		Histeresis	1.0	0,1...99999 (parameter active, when the Archive type is different from Interval)
Group 2				
Group 3				
		same as Group 1		
CSV settings				
		Value separator	Comma	Comma: a separator is ',' Semicolon: a separator is ';' Tabulator: a separator is a tab character
		Decimal separator	Dot	Dot: a integer separator is '.' Comma: a integer separator is ','
Actions...				
		Rip archive on SD card		Saving all the new records on the SD card (Only records that have been recorded since the last download to the SD card are downloaded)
		Clear archive		Clear the entire archive
Modbus				
		Address	1	1...247
		Baudrate	9600 bps	4800 bps 9600 bps 19.2k bps 38.4k bps 57.6k bps 115.2k bps

		Mode	RTU 8N2	Off RTU 8N2 RTU 8E1 RTU 8O1 RTU 8N1
Modbus TCP <sup>2)</sup>				
		Enabled	Yes	No Yes
		Port	502	0...65535
Modbus master				
Settings				
		Baudrate	9600 bps	4800 bps 9600 bps 19.2k bps 38.4k bps 57.6k bps 115.2k bps
		Mode	RTU 8N2	Off RTU 8N2 RTU 8E1 RTU 8O1 RTU 8N1
		Delay between polls	300	100...5000 ms
Master 1				
		Master 1	Off	Off: modbus master off On: modbus master on
		Address	1	1...247
		Work mode	Manual	Manual: it must be manually configured: „Base register”, „Nr of values” and „Value type” Template: reading the value from the device indicated in „Template”

		Template	P18, P18D, P19	<p><b>P18, P18D, P19</b>  T - register 7501 - measured temp.  RH - register 7502 - measured relative humidity,  DP - register 7503 - dew point calculated  AH - register 7504 - calculated absolute humidity</p> <p><b>P30U</b>  DISP VAL1 - register 7505 - displayed value,  MEAS VAL - register 7510 - measured value,  DISP VAL2 - register 7512 - second displayed value</p> <p><b>P18S</b>  T - register 7501 - measured temperature,  RH - register 7502 - calculated absolute humidity  DP - register 7503 - calculated dew point  AH - register 7504 - calculated absolute humidity</p>
		Base register	4000	0...65535
		Nr of registers	1	1...10
		Register type	ushort 16	char 8: <i>char</i> register (8 bits with character) uchar 8: <i>unsigned char</i> register (8 bits without character) short 16: <i>short</i> register (16 bits with character) ushort 16: <i>unsigned short</i> register (16 bits without character) long 32: <i>long</i> register (32 bits with character) ulong 32: <i>unsigned long</i> register (32 bits without character) float 32: <i>float</i> register (32 bits, variable comma with character) sw float 2x16: <i>swapped float</i> register, value placed in two 16bit registers (byte order 3,2,1,0)

				<p>float 2x16: <i>float</i> register, value placed in two 16bit registers (byte order 1,0,3,2)</p> <p>long 2x16: <i>long</i> register, value placed in two 16bit registers (32 bits with character, byte order 1.0,3,2)</p> <p>sw long 2x16: <i>swapped long</i> register, value placed in two 16bit registers (32 bits with character, byte order 3,2,1,0)</p> <p>ulong 2x16: <i>unsigned long</i> register, value placed in two 16 bit registers (32 bits without character, byte order 1.0,3,2)</p> <p>sw ulong 2x16: <i>swapped unsigned long</i> register, value placed in two 16 bit registers (32 bits without character, byte order 3,2,1,)</p>
		Interval	5000	5...36000 ms
		Max response time	2000	100...5000 ms
		Req. master function	Function 0x03	Function 0x03 Function 0x04
		Max nr of req	0	0...10
Master 2				
		same as Master 1		
FTP <sup>2)</sup>				
		Enabled	Yes	No Yes
		Port	21	0...65535



WWW <sup>2)</sup>				
		Enabled	Yes	No Yes
		Port	80	80...32000
Ethernet <sup>2)</sup>				
		DHCP	On	Off: off On: on
		Mode	Auto	Auto: autonegation of baudrate 100M FDX: 100Mbit full duplex 100M HDX: 100Mbit half duplex 10M FDX: 10Mbit full duplex 10M HDX: 10Mbit half duplex
		IP Address	127.0.0.1	0.0.0.0...255.255.255.255
		Subnet mask	255.0.0.1	0.0.0.0...255.255.255.255
		Gateway Address	0.0.0.0	0.0.0.0...255.255.255.255
Security				
Admin				
		Enabled	Yes	No Yes
		Password		0...99999999
User 1				
		Enabled	Yes	No Yes
		Level	Level 2	Level 0: all parameters change Level 1: change of all parameters .other than the Security submenu Level 2: change of SP, program number, clock settings
		Password		0...99999999

User 2			
		same as User 1	
User 3			
		same as User 1	
Settings			
		LCD Backlight	100% 0...100 %
		Backlight OFF	00:00:00 00:00:00...01:00:00 Entering the value 00:00:00 disables the function
		Show screens	5/13 <ul style="list-style-type: none"> <li>● Loop 1</li> <li>● Loop 2</li> <li>● Loop1/2</li> <li>● 1st val screen</li> <li>○ 2nd val screen</li> <li>○ 3rd val screen</li> <li>○ Timers</li> <li>○ Timer 1</li> <li>○ Timer 2</li> <li>○ Timer 3</li> <li>○ Timer 4</li> <li>○ Timer 5</li> <li>○ Timer 6</li> </ul>
		Screens switching time	00:00:00 00:00:00.....01:00:00 (hh:mm:ss) Range of changes from 1 sec to 1 hour
		Language	Polish English Polish Deutsch
		Show OutStates	No No Yes
		Show EvStates	No No Yes
		Show Clock	No No Yes

		Hours		
		Date		
		Set Defaults		Revert to manufacturer's settings (other than Ethernet group settings)
Information				
		Type	RE92	
		Boot Version	eg. 1.00	
		Program version	eg. 1.00.00	
		Serial number	eg. 12010001	
		MACAddress <sup>2)</sup>		

- 1) – default setting and extent of the changes depends on input 3 field in the ordering code  
 2) – shown for Ethernet version

## 7.4. Language selection

The preset language is English. To select a different language, press and hold the Menu button for about 10 seconds. The language selection menu will appear. The language selection is made with the  or  buttons and then confirmed again by pressing the OK button.

## 8. INPUTS AND OUTPUTS OF THE CONTROLLER

---

RE92 controller is fitted with two measuring inputs, one two interface inputs (from slave devices through modbus master), three binary inputs -hardware, three modbus binary inputs.

### 8.1. Measuring inputs 1

Input 1 is the source of the measured value used for control and alarms.

Input 1 is an universal input capable of accommodating various sensors or standard signals. Input signal is selected with a [**Input type**] parameter. Displayed unit is set through the [**Unit**] parameter. Position of the decimal point that determines measured and set values is set through the [**Digit Point**] parameter.

For thermocouple, a cold terminal compensation must be set through a [**CJC Type**] parameter. When the [**CJC Type**] parameter is set to [*Auto*], compensation is automatic; when it is set to [*External*], the compensation temperature is set by the [**CJC Temp**] parameter.

For the linear inputs, set the indication for the lower and upper analog input threshold through the [**LowScale**] and [**HighScale**] parameter.

Correction of the indicated measuring value is done through the [**Shift**] parameter.

When the measuring value is unstable, a digital filter with a programmable time constant value may be used. When using this feature, use the lowest filter time constant value that allows for the stable measuring value. When the time constant is too high, it may cause the control to become unstable. The range of a filter time constant – a [**Filter**] parameter – may



be set to 0.2 to 100 seconds.

Measuring input 1 parameters can be found in menu: Inputs → Analog input 1.

## 8.2. Measuring input 2

Input 1 is the source of the measured value used for control and alarms.

Measuring input 2 parameters are the same as the ones for input 1 can be found in menu: Inputs → Analog input 2.

## 8.3. Measuring input 3

Input 3 may be used as:

- signal controlled for any loop (as the independent input or component for compound signal on different input),
- set value for any loop,
- additional measurement point – displayed on a measurement screen.

Input 3 is an input that can accommodate the standard signals. Input signal is selected with a **[Input type]** parameter. Displayed unit is set through the **[Unit]** parameter. Position of the decimal point that determines measured and set values is set through the **[Digit Point]** parameter.

Set the indication for a lower and upper analog input threshold through the **[LowScale]** and **[HighScale]** parameter.

Correction of the indicated measuring value is done through the **[Shift]** parameter.

When the measuring value is unstable, a digital filter with a programmable time constant value may be used. The range of a filter time constant – a **[Filter]** parameter – may be set to 0.2 to 100 seconds.

Measuring input 3 parameters can be found in menu: Inputs → Analog input 3.

## 8.4. Interface inputs 1, 2

Interface inputs 1 and 2 can be used as:

- adjustable signal for any loop,
- set value for any loop.
- reference signal for controlling the alarms,
- source of retransmitted signal to analog output

Interface inputs 1 and 2 are inputs for which the measured values are read by the function of modbus master 1 or 2. Selecting the measured value is done with the [**Assignment**] parameter, where you select the device from which you read the values of the registers (Master 1 or Master 2) and indicate the register to be assigned as the measured value [**Register Number**]. The displayed unit is set by the [**Unit**] parameter. The position of the decimal point that determines the display format of the measured value and set point value is set by [**Digit point**].

Correction of the indicated measured value is done with the [**Shift**] parameter.

If the measured value is unstable, a digital filter with programmable time constant value can be used. Filter time constant – parameter [**Filter**] can be set from 0.2 to 100 second.

Parameters concerning external inputs 1 and 2 can be found respectively in menu: Inputs → Input modbus 1, Inputs → Input modbus 2.

## 8.5. Binary inputs

The function of the binary inputs are set through the [**Function**] parameter that can be found in: menu: Inputs → Binary input 1, Inputs → Binary input 2 and Inputs → Binary input 3.

The controller is also equipped with three additional modbus binary slave inputs - controlled via the interface.

Function of interface binary inputs is set through the [Funkcja] parameter, that can be found in menu: Inputs → Modb binary input 1, Inputs → Modb binary input 2 i Inputs → Modb binary input 3.

Then you need to allocate binary inputs to the appropriate loop.

The following functions of the binary input are available:

- **no function** – state of binary input does not influence the controller operation,
- **stop** – during active binary input the control is interrupted and control outputs start to function as after sensor failure; alarm and retransmission operate normally,
- **switch to manual** – during active binary input, the controller is in the manual operation mode,
- **switch to the next SP** – during active binary input the set point value is switched to another (eg. from SP1 to SP2)
- **program start** – after activation of binary input, the process of programming control starts,
- **jump to next segment** – after activation of binary input, follows the jump to the next segment of programming control,
- **stop counting program set value** – during active binary input, follows the stop of set value counting for programming control
- **end of the program** – jump to the end of the program after activation of the binary input,
- **stop of the program with possible continuation** – control stop and the program stop at the current position after activation of the binary input,
- **stop the program and jump to the beginning** – control stop and the program jump to start after activating the binary input,
- **source for SP from input 1, 2 or 3** – by active binary input

the set point is switched to the value from any measuring or interface input

- **Alarm timer reset** – enabling the binary input turns off the alarm relay responsible for the alarm timer and reset of the timer.
- **cyclic switching between SP** – after activating the binary input, the setpoint is switched to the next loop (SP1 >> SP2 >> SP3 >> SP4 >> SPIN1 >> SPIN2 >> SPIN3 >> SPMd1 >> SPMd2 >> SP1),
- **Out Min/Max 2** - switching to the second set of parameters for limiting the control signal

### Note!

If one channel is assigned to more than one binary input, than for each of them must be set a different function.

## 9. CONTROLLER OUTPUTS

---

RE92 controller has six binary outputs and two analog outputs: current and voltage (optional).

### 9.1. Controlling outputs

[Heaf] function output is a reverse output. It is used during control, when the increase of the controlled signal causes the value of output signal to drop. Such output is allocated during the loop configuration to the heating control, heating loop in the heating cooling control or valve opening in the step-by-step control.

[Coo] function output is a non-reverse output (direct). It is used during control, when the increase of the controlled signal causes the value of output signal to increase. Such output is allocated during the loop configuration to the cooling control, cooling loop in the heating-cooling control or valve closing in the step-by-step control.

For the proportional control (with the exception of the analog outputs) an impulse period is also set. Impulse period is a time between two subsequent input engagements during proportional control. Impulse period length should be adjusted for the dynamic properties of the object and characteristics of the output device. It is recommended to use SSR transmitter for quick processes. Relay output is used for a contactor control in the slow-changing processes. Long impulse periods for quick-change processes may cause unnecessary oscillation. In theory, the shorter impulse period is, the better the control, however for the relay output a period should be as large, as possible to optimize lifespan of the relay.

Impulse period setting recommendations

Table 2

Output	Impulse period is	Load
electromagnetic transmitter	recommended >20 s, min. 10 s	2 A/230 V a.c.
	min. 5 s	1 A/230 V a.c.
transistor output	1...3 s	semiconductor transmitter (SSR)

## 9.2. Alarm outputs

Alarm configuration is done in two steps:

1. In **[Output k]** submenu - where  $k=1\dots6$  (menu: Outputs):
  - select the number of loop or input allocated to the output being configured – **[Assignment]** parameter,
  - set **[Function]** parameter to *[Alarm]*.
2. In *[Alarms]* submenu, for every output defined as alarm output, please set:
  - alarm type – **[Type]** parameter,
  - set value – **[SP]** parameter - it is the controlled or measuring signal value that engages the input,
  - deviation from the value set in the loop **[Deviation]** parameter - it is the control deviation that engages the input,
  - input engagement hysteresis – **[Hysteresis]** parameter - a zone around the point of alarm operation in which output state does not change,
  - alarm memory - **[Latch]** parameter, *[Yes]* - means that the alarm will be locked until confirmed by operator.

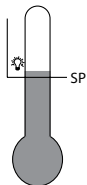

absolute high  
*[AbsHigh]*

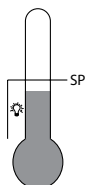

absolute lower  
*[AbsLo]*

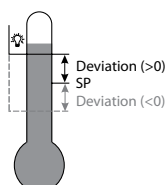

relative high  
*[DevHigh.]*

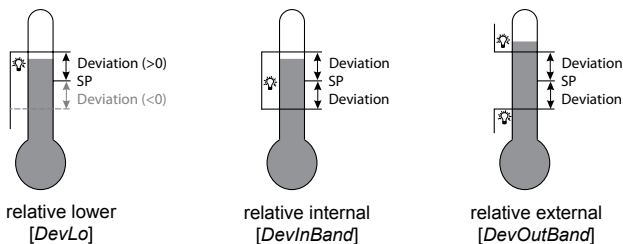

Fig.18. Alarm types

### 9.3. Timer function

Timers configuration is done in two steps:

- In **[Output k]** submenu - where  $k=1\dots 6$  (menu: Outputs):
  - select the number of loop or input allocated to the output being configured – parameter **[Assignment]**,
  - the parameter **[Function]** set to **[Timer]**.
- In **[Timer k]** submenu - where  $k=1\dots 6$  (menu: Timers) for each timer:
  - enable timer function – parametr **[Function]**,
  - set time – parametr **[Time]** – it is time from which, upon the controller reaches the set point temperature (SP), the timer starts counting down. Alarm timer is set and a relay responsible for the alarm timer is actuated after deduction to zero,
  - select the type of output latch – parameter **[Uphold output]**
  - select time of output latch – parameter **[Uphold time]** – it is time which starts to be counted down when the alarm timer is set and the relay responsible for the alarm timer function is actuated. Alarm timer is reset and a relay is switched off after deduction to zero,

- select the alarm type – parameter [Type] – set this parameter if in the [Output -> Assignment] submenu is selected: **Input 1, Input 2, Input 3, INP1+2+3,**
- set a set point – parameter [SP] - set this parameter if in the [Output -> Assignment] submenu is selected: **Input 1, Input 2, Input 3, INP1+2+3.**

If in the [Output -> Assignment] submenu is selected: **loop 1** or **loop 2** a timer function works for a control only: **heating, cooling.**

Reset the timer to update the parameters in case of any settings were changed on the enlarged timer screen.

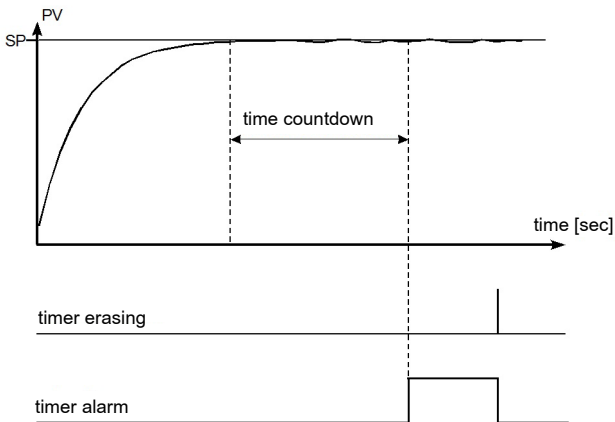

Fig. 19. The principle of operation of the timer during a continuous latch.



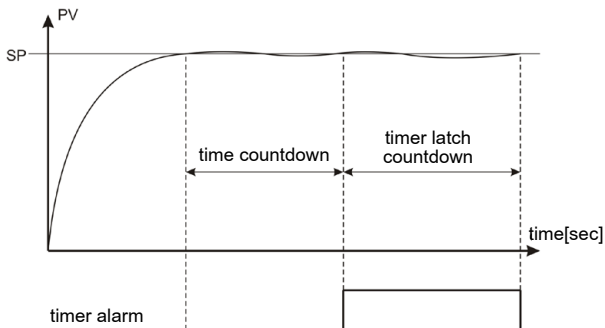

Fig. 20. The principle of operation of the timer during a timer latch.

## 9.4. Retransmission outputs

Analog output may be used for retransmission of the selected value, e.g. for registering object temperature or copying set values in multi-zone furnaces.

Signal retransmission is possible if the controller is fitted with analog output 1 or 2.

Set **[Function]** parameter to **[Retransmiss]**. Type of a signal to be retransmitted is set through the **[Retr Source]** parameter. Signal can be chosen from: **[PV]** – controlled signal, **[Deviation]** – control deviation a **[SP]** – set point value. The next parameter, **[Output Type]**, sets the analog output range. Additionally, it is necessary to set upper and lower limit of the signal to be retransmitted **[Retr Min]** and **[Retr Max]**.

Retransmission output parameters can be found in menu: Outputs → Analog output 1 and Outputs → Analog output 2.

Picture 21 shows method of transforming the retransmitted signal into proper analog output signal.

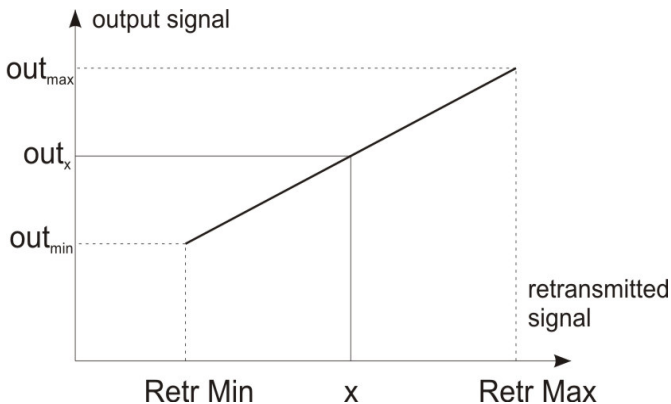

*Fig. 21. Transformation of the signal to be retransmitted*

The [**Retr Min**] parameter may be higher than [**Retr Max**], but this will cause the output signal to be inverted.

## 9.5. Signal outputs

Any binary output can be used for „retransmission” of the state of given binary input, the specified binary input interface register, or the register directly controlling the binary output. To do this, while configuring the [**Assignment**] parameter choose the:

- [EvIn1] – binary input 1 short-cut will activate the output,
- [EvIn2] – binary input 2 short-cut will activate the output,
- [EvIn 3] – binary input 3 short-cut will activate the output,
- [EvIn1Neg] – binary input 1 release will activate the output,

- [EvIn2Neg] – binary input 2 release will activate the output,
- [EvIn3Neg] – binary input 3 release will activate the output.
- [ModbEvIn1] – (register 4055) entering value 1 into register activates the output,
- [ModbEvIn2] – (register 4056) entering value 1 into register activates the output,
- [ModbEvIn3] – (register 4057) entering value 1 into register activates the output,
- [ModbEvIn1Neg] – (register 4055) entering value 0 into register activates the output,
- [ModbEvIn2Neg] – (register 4056) entering value 0 into register activates the output,
- [ModbEvIn3Neg] – (register 4057) entering value 0 into register activates the output,
- [ModbReg] – entering value 1 into the following register activates the:
  - output 1 (register 4058),
  - output 2 (register 4059),
  - output 3 (register 4060),
  - output 4 (register 4061),
  - output 5 (register 4062),
  - output 6 (register 4063),
- [ModbRegNeg] – entering value 0 into the following register activates the:
  - output 1 (register 4058),
  - output 2 (register 4059),
  - output 3 (register 4060),
  - output 4 (register 4061),
  - output 5 (register 4062),
  - output 6 (register 4063).

## 10. LOOP CONFIGURATION

---

### 10.1. Controlled signal

The signal controlled in a loop might be a measurement from the selected source (Inp1, Inp2, Inp3, Modbus In1, Modbus In2) or combination of the measured values from two inputs ( Inp1 + Inp2, Inp1+ Inp3, Inp2 + Inp3).

Combined control signal is calculated by the controller, using the following formula:

$$\text{Controlled signal} = [\text{Coeff. for Inp } k] * \text{Inp } k + [\text{Coeff. for Inp } k] * \text{Inp } k$$

Where k is a input number (1...3).

#### Example 1:

To control the difference between input 2 and input 3 signals, enter:

[PV]= [Inp2+Inp3]; [Coeff for Inp 2] = 1,0 [Coeff. for Inp 3] = -1,0.

#### Example 2:

To control the mean of input 1 and input 2 signals, enter:

[PV] = [Inp1+Inp2]; [Coeff. for Inp 1] = 0.5 [Coeff. for Inp 2] = 0.5.

### 10.2. Control types

#### **Heating-type control**

Controller uses this type of control when the parameter [**Control Type**] in menu: Loop 1 → Control or Loop 2 → Control is set to [*Heat*]. It is a reverse control, when the increase of the controlled signal causes the value of output signal to drop. Output

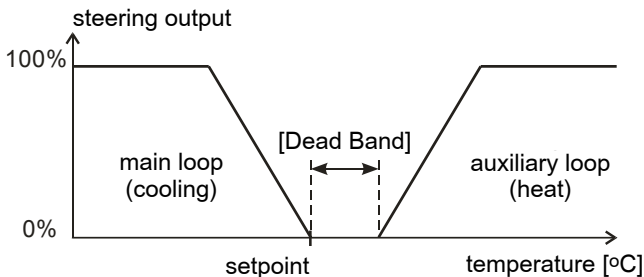

Fig. 22. Control with two heating-cooling loops

### Three-step, step-by-step control

The controller offers two algorithms of the step-by-step control for cylinder control:

- with no feedback signal from the valve – opening and closing of the valve is based on PID parameters and control deviation,
- with the feedback signal from the valve positioning device – opening and closing of the valve is based on PID, control deviation and valve position read from the input 3.

To select the three-step step-by-step control, the [**Control Type**] parameter in menu: Loop 1 → Control or Loop 2 → Control should be set to [*Valve*] or to [*Valve Fdb*]. For every control loop, set the insensitivity range for the set point, in which the valve does not change its position - the parameter [**Dead Band**] and select the set of PID parameters. Auto-tuning algorithm is not available for the step-by-step control.

Step-by-step control with no feedback additionally requires the parameters settings: valve open time [**Valve Open Time**], valve close time [**Valve Close Time**], minimum valve work time [**Min Work Time**].

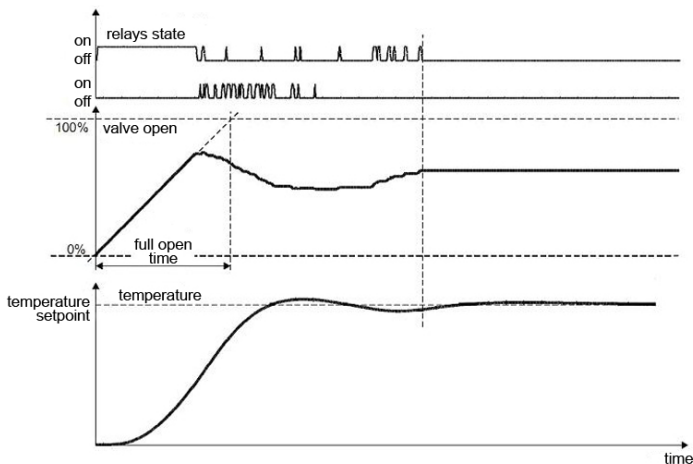

*Fig.23. Three-step step-by-step control with no feedback*

The principle of the algorithm shown in Fig. 23 is based on conversion of changing the control signal to the relay opening / closing time referred to the full opening / closing time.

The differences between the calculated and the actual valve position are unavoidable because of multiple changes in the direction of valve movement due to the inertia of a drive or its wear in the absence of a feedback. The controller uses the function of automatic positioning of a drive during operation to eliminate these differences. This function does not require user intervention and its function is to extend switching on time of the relay when the control signal reaches 0% or 100%.

The relay for opening / closing will remain on for a time equal to the time of a valve full open / close from a moment of a signal reaching 100% / 0%.

The positioning of the valve will be stopped once the signal is equal to the maximum value.

In the specific case, the positioning is performed by completely closing the valve, it is carried out each time after:

- turning the controller supply on
- changing full open / close time.

The time of full opening of the valve can have a different value than the time of closing.

Both parameters should be set to the same value when using a drive with identical times.

## Cascade control

Cascade control is used in the processes with a high latency to obtain the best quality of control.

Second loop works as a slave controller which controls the output. First loop works as the master controller and sets the set point for the slave controller.

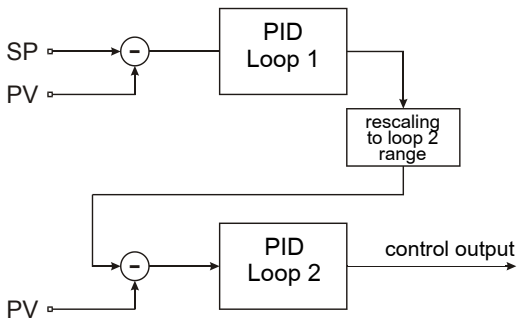

Fig. 24. Cascade control

First loop should be set to PID control to select the cascade control. In the second loop the parameter [**Control type**] in menu: Loop 2 → Control should be set to [*Cascade*]. For rescaling the master loop output set the parameters [**Casc.SO Lo**] and [**Casc.SO Hi**] in menu: Loop 2 → Set value.

## „Gain Scheduling” Function

For control systems, where the object behaves decidedly differently in various temperatures, it is recommended to use the „Gain Scheduling” function. The controller allows to remember up to four sets of PID parameters and switch them over automatically. Switching between PID sets runs percussiveless and with a hysteresis to eliminate the oscillations on switching limits.

The parameter [**Typ GS**] settles the way of the function operation.

[Off]	The function is disabled
[SP]	<p>a) Switching depending on the set point value. Additionally, one must also choose the number of PID sets – parameter [<b>GS Level Nb</b>], and set their switching levels in dependence from the number of PID sets [<b>GS Level 1-2</b>], [<b>GS Level 2-3</b>], [<b>GS Level 3-4</b>].</p> <p>b) For the programmed control, one can set the PID set individually for each segment. First, for the given program, one must set the parameter [<b>Gain Scheduling</b>] in the menu: Programs → Program x → Config Prg to [<i>On</i>].</p>
[Set]	Permanently setting of one PID set. The PID set is set through the [ <b>GS Set</b> ] parameter.



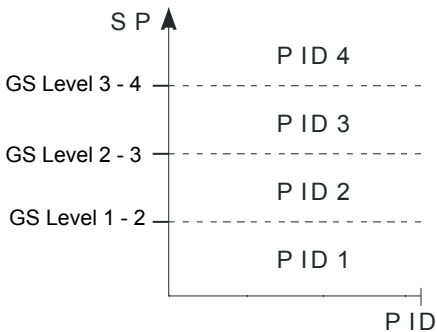

Fig.25. "Gain Scheduling" switched over from SP

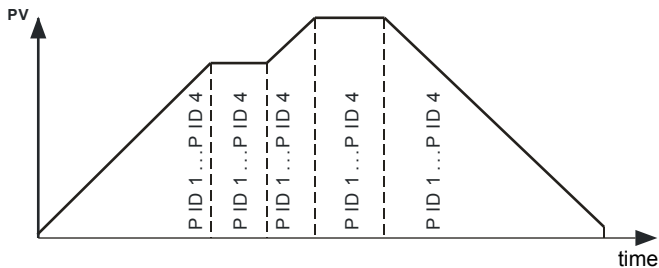

Fig. 26. „Gain Scheduling" switched over for each segment in the programmed control.

## 10.3. Control range

Control range is defined by **[Ctrl Lim Lo]** and **[Ctrl Lim Hi]** parameters. Control range defines limits for the PID control and auto-tuning algorithm.

## 10.4. Set value in loop

A set value in loop may be one of the four values defined as SP1, SP2, SP3, SP4, value read from the input 1, 2, 3, Modbus In1, Modbus In2 or one of the PRG programs.

### **Soft start**

If the value is controlled in loop via SP1, SP2, SP3 or SP4, it is possible to determine an allowable speed of controlled changes (i.e. soft start) during object activation or while changing the set value. It allows for smooth achievement of a target value without re-regulation. When accrual process starts, temporary set value changes from the measured value to the set value allocated to a loop. Selection of the Ramp rate unit between *[rate/min]* and *[rate/h]* is set in the **[Ramp Mode]** parameter, and the Ramp rate in the **[Ramp Rate]** parameter.

## 10.5. Control algorithms

### **on-off algorithm**

When high accuracy of a temperature control is not required, especially for the high time constant and small delay, it is possible to use on-off control with hysteresis. This method ensures simple and reliable control, its downside is the oscillation, even at low hysteresis values.

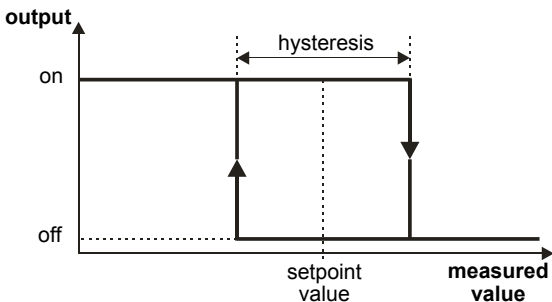

*Fig. 27. Heating output operation*

### **SMART PID algorithm**

When high precision of the temperature control is necessary, it is recommended to use PID algorithm. Innovative SMART PID algorithm ensures increased precision in the extended range of the control object classes.

Tuning of the controller to object is achieved by manual setting of the proportional term, derivation term or difference term or automatically – by auto-tuning function.

### **Proceeding in case of a unsatisfactory PID control**

PID parameters are best selected by doubling or halving the value. The following rules should be observed during changes:

#### **a) Oscillations**

- increase the proportional band,
- increase integration time,
- decrease the differentiation time,

#### **b) Over-regulations**

- increase the proportional band,
- increase integration time,
- increase the differentiation time,

c) Instability

- decrease the proportional band,
- decrease the differentiation time,

d) Free jump response:

- decrease the proportional band,
- decrease integration time.

Trace of controlled value	Controller operation algorithms			
	P	PD	PI	PID
	Pb↑	Pb↑ td↓	Pb↑	Pb↑ ti↑ td↓
	Pb↑	Pb↑ td↑	Pb↑ ti↑	Pb↑ ti↑ td↑
		Pb↓ td↓		Pb↓ td↓
	Pb↓	Pb↓	ti↓	Pb↓ ti↓

Fig.28. PID parameters correction method

## Auto-tuning

The controller has the function to select PID settings. In most cases these settings ensure an optimal control.

To begin the auto-tuning, one must select the field **[ST]** on the screen of a single loop with fixed set-point control and then press a button **[Exec.]** For the correct execution of the auto-tuning function, the setting of **[Ctrl Lim Lo]** and **[Ctrl Lim Hi]** parameters is required. The parameter **[Ctrl Lim Lo]** should be set on the value corresponding to the measured value at the switched off control. For object temperature control, one can set 0°C. The parameter **[Ctrl Lim Hi]** should be set on the value corresponding to the maximum measured value when the control is switched on the full power.

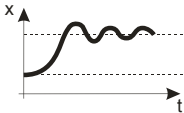
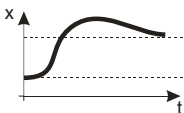
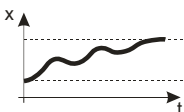
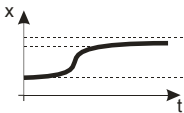
Message: SELF symbol in the control status field informs about the activity of the auto-tuning function. The duration of auto-tuning depends on dynamic object properties and can last maximally 10 hours. During auto-tuning or directly after it, over-regulations can occur and because of this, one must set a smaller set point if possible.

The auto-tuning is composed of following stages:

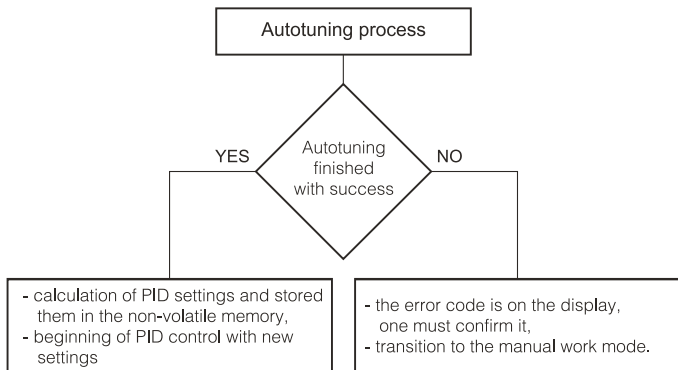

The auto-tuning process will be stopped without counting PID settings, if a supply decay occurs or the field **[ST]** will be again selected and confirmed.

If the auto-tuning is not achieved with success, the error message will be displayed.

### **Auto-tuning and „Gain Scheduling”**

In case, when „Gain Scheduling” is used, one can carry out the auto-tuning in two ways.

The first way consists on choosing a suitable set of PID parameters, in which calculated PID parameters will be stored and realizing the auto-tuning

on the level of the currently chosen set point value for the fixed set point control. One must set the parameter **[GS Type]** in the menu: Loop x → Gain Scheduling to **[Set]**, and select the parameter **[GS Set]** between **[PID1]** and **[PID4]**.

The second way enables an automatic realization of the auto-tuning for all PID sets. One must set the **[GS type]** to **[SP]**, and choose a number of PID sets for setting - the parameter **[GS Level Nb]** Set point values for the individual PID sets must be provided in the parameters **[SP1]**, **[SP2]**, **[SP3]**, **[SP4]** in the menu: Loop x → Set point value from the lowest to the highest.

# 11. PROGRAMMING CONTROL

## 11.1. Description of the programming control parameters

List of configuration parameters

Table 3

[Programs] – programs defined for programming control				
[Program 1] - program 1 submenu				
:				
[Program 60] - program 60 submenu				
[Prg.Conf.] - podmenu parametrów programu				
Symbol of parameter	Parameter description	Factory setting	Parameter modification range	
			sensors	linear input
PrgStart	Program start method	Start SP	Start SP: from the value defined by SP0 Start PV: from the current measured value	
SP mode	Initial set value	0,0 °C	MIN...MAX <sup>1)</sup>	
Time Unit	Unit of the segment duration time	mm:ss	mm:ss: minutes and seconds hh:mm: hours and minutes	
Ramp Unit	Unit of the set value Ramp rate	Min	Min: minutes Hour: hours	
Holdback Type	Block from the control deviation	Off	Off: inactive Lower: lower Upper: upper Intern.: two-sided	

	Cycles Number	Program iteration no.	1	1...999	
	Power Fail	Control after supply decay	Continuation	Continuation: program continuation Stop: control stop	
	End Type	Program end control	Stop	Stop: control stop Last SP: fixed set-point control with set value from last segment	
	Gain Sched.	"Gain Scheduling" function for program	Off	Off: off On: on	
[Segment 1] – segment no. 1 parameters submenu					
:					
[Segment 15] – segment no. 15 parameters submenu					
	Symbol of parameter	Parameter description	Factory setting	Parameter modification range	
				sensors	linear input
	Seg.Type	Segment type	Time	Time: time-defined segment Accrual: accrual-defined segment Hold: set value hold End: program end	
	Target SP	Set value at the end of a segment	0,0 °C	MIN...MAX <sup>1)</sup>	



Seg.Duration	Segment duration	00.01	00.01...99.59 <sup>2)</sup>	
Ramp Rate	Set value Ramp rate	0.1	0.1...550.0 °C / time unit <sup>4)</sup> (0.1...990.0 °F / time unit <sup>4)</sup> )	1...5500 °C <sup>3)</sup> / time unit <sup>4)</sup> (1...9900 °F <sup>3)</sup> / time unit <sup>4)</sup> )
Holdback Val	Upper control deviation value; after it is exceeded, set value accrual is stopped	0	0.0... 200.0 °C (0.0...360.0 °F)	0...2000 °C <sup>3)</sup> (0...3600 °F <sup>3)</sup> )
Event 1	Event 1 state	Off	Off: off On: on	
Event 2	Event 2 state	Off	Off: off On: on	
Event 3	Event 3 state	Off	Off: off On: on	
Event 4	Event 4 state	Off	Off: off On: on	
Event 5	Event 5 state	Off	Off: off On: on	
Event 6	Event 6 state	Off	Off: off On: on	
PID set	PID set for a segment	PID1	PID1: PID1 PID2: PID2 PID3: PID3 PID4: PID4	

1) See TBD table.

2) Time unit is defined by the [Time unit] parameter

3) Resolution of the parameter depends on the [Dot.pos,] parameter, i.e. position of the decimal point.

4) Ramp unit is defined by the [Ramp Unit] parameter

## 11.2. Defining the set value programs

Up to 60 programs may be defined. One program may include up to 15 sections.

To ensure that parameters related to the programming control are displayed in the menu, a **[SP Mode]** parameter must be set to *[PRG]*. It is then possible to set and additionally enable the permission to start programming control at a given time. Every program must have parameters set in the program parameters submenu. For every segment, select a segment type and proper parameters according to the segment type, as indicated in the table 4.

List of segment configuration parameters

Table 4

<b>[Seg.Type] =</b> <i>[Time]</i>	<b>[Seg.Type] =</b> <i>[Rate]</i>	<b>[Seg.Type] =</b> <i>[Dwell]</i>	<b>[Seg.Type] =</b> <i>[End]</i>
Target SP	Target SP	Segment time	
Segment time	Ramp rate		
Holdback Val	Holdback Val		

Picture 29 and table 5 show an example of set value program. The program assumes that the object temperature should increase from initial temperature to 800°C with a rate of 20°C per minute with active deviation block.

The temperature is then maintained for 120 minutes (block disengaged), and then drops to 50°C through 100 minutes (block disengaged); during object cooling it is necessary to engage the fan connected to the output 2 (in Outputs → Output2 menu: **[Function]** parameter set to *[Prg Event]* and **[Prg Event]** parameter set to *[SegEvent1]*).

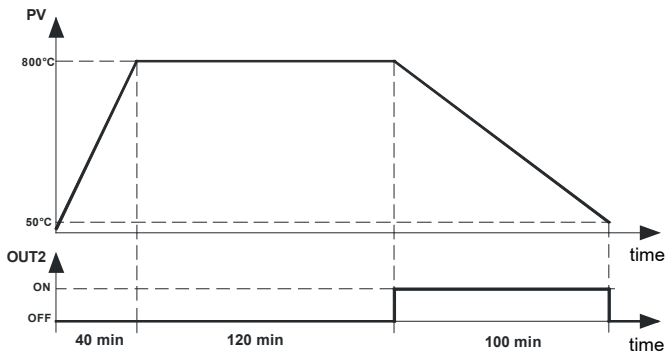

Fig.29. Example program

Parameter value for the example program

Table 5

	Parameter	Value	Meaning
Config. Prg	PrgStart	<i>Start PV</i>	Set value accrual start from the initial (current) temperature
	Time Unit	<i>hh:mm</i>	The unit of time: hours and minutes
	Ramp Unit	<i>Min</i>	Ramp rate unit: minutes
	Holdback Val	<i>Intern.</i>	Program block active - double-sided
	Cycles Number	<i>1</i>	Program iteration no.
	Power Fail	<i>Continuation</i>	Program continuation after supply decay
	End Type	<i>Stop</i>	Control end after program closes

Segment 1	Seg.Type	<i>Accrual</i>	Segment type: Ramp rate
	Target SP	<i>800</i>	Target set value: 800.0 °C
	Ramp rate	<i>20</i>	Ramp rate 20.0 °C / minute
	Holdback Val	<i>50</i>	Block active when deviation is higher than 50.0 °C
	Event 1	<i>Off</i>	Events 1 on output 2: off
Segment 2	Segment type	<i>Segment time</i>	Section type: segment duration time
	Segment time	<i>02.00</i>	Segment time 2h00 = 120 minutes
	Event 1	<i>Off</i>	Events 1 on output 2: off
Segment 3	Segment type	<i>Segment time</i>	Section type: segment duration time
	Target SP	<i>50</i>	Target set value: 50.0 °C
	Segment time	<i>01.40</i>	Segment time 1h40 = 100 minutes
	Holdback Val	<i>0</i>	Block inactive
	Event 1	<i>On</i>	Events 1 on output 2: on
Segment 4	Segment type	<i>End</i>	Section type: program end
	Event1	<i>Off</i>	Events 1 on output 2: on

## 12. ARCHIVING

---

### 12.1. Introduction

The controllers with the Ethernet interface are equipped with an internal memory for storing archived data. Archiving is divided into three independent groups. The internal memory allows you to register up to 1.2 million records in each group. The memory is a ring buffer type one.

### 12.2. Archiving configuration

To start the archiving in any group, select the submenu [**Group n**], the group in which the archiving is to take place and then:

- select which values are to be archived – parameter [**Parameters**],
- select the archiving type – parameter [**Archive type**],

Then, depending on the archiving type, you need to configure the other parameters:

Archiving type	Parameters to be set
<b>Interval</b>	Set the time at which you want to archive the selected values – parameter [ <b>Interval</b> ]
<b>AbsHigh AbsLo</b>	Select a value triggering the archiving – parameter [ <b>Trigger</b> ], set the time at which you want to archive the selected values – parameter [ <b>Interval</b> ], set the archiving threshold – parameter [ <b>SP Abs</b> ] and the hysteresis – parameter [ <b>Hysteresis</b> ]
<b>AbsHigh AbsLo DevInBand DevOutBand</b>	Select a value triggering the archiving – parameter [ <b>Trigger</b> ], set the time at which you want to archive the selected values – parameter [ <b>Interval</b> ], set the relative archiving threshold – parameter [ <b>SP Dev</b> ], deviation - parameter [ <b>Deviation</b> ] and the hysteresis – parameter [ <b>Hysteresis</b> ]

- attach the group of archiving – parameter [**Arch. ON/OFF**] set to [**ON**]
- configure CSV file settings – submenu [**CSV settings**] - parameter [**Value separator**] and [**Decimal separator**]

## 12.3. Copying archive to SD card

Because the size of a single file on the SD card is limited to approx. 10 MB, after the internal memory is full with the number of the records (approx. 35 thous.), which correspond to a file size approx. 10MB, the recorded data will be copied to the SD card in the text file with „.csv” extension . If the SD card will not be inserted to the regulator, data being archived will be available in the internal memory as long as they are overwritten with the new ones. If until the last copy process of the archive, the regulator will archive over 35 thousand new records (equivalent of the file > 10 MB on the SD card), then right after inserting the SD card the controller will start to copy the archive to the SD card dividing date by the file of approx. 10MB each.

Example: Before the oldest data will be overwritten, the internal memory with the archiving period of 5 seconds allows to register for about 73 days / group without having to copy them to the SD card. Note however, that copying the entire archive takes a lot of time. It is recommended not to remove the SD card from the controller for a longer period of time or copy the archive to the SD card more frequently.

Copying recorded data on the SD card can be forced at any time in the submenu [**Archiving** → **Actions...** → **Rip archive on SD card**] or via the interface MODBUS, MODBUS TCP/IP (register 4037).

Use an SD card class 10 or higher for the archiving. If while copying the archive, the SD card inserted into the controller will be too slow, then the message to use another SD card will be displayed on a screen and copy of the archive on the card will be canceled.

### **Caution!**

**Data once copied to the SD card are marked in the controller as data to be erased, and they can not be re-copied to the card.**

The controller creates the directories and the files on the memory card while the archive is being copied. An example of the directory structure is shown in Fig. 30.

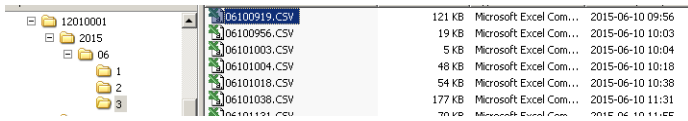

Fig.30. An example of the directory structure on the SD card

Data on the SD card are stored in the files in the directories (the serial number of the controller), then (year, month of archive copy) – see Rys. 30. The file names are marked as a month, day and time of a copy of the first record, and they have the format MMddhhmm.csv where: MM-month, dd-day, hh-hour, mm-minute.

## 12.4. Archive files structure

The archived data files on the SD card are in the form of the columns, where each column of data is separated by a comma (depends on the settings). A column description is in the first line of the file. Data records are sequentially arranged in the rows. An example of the file is shown in Fig. 31.

DATE, TIME, FREQ, S, POWER, D, LOSS, FREQRES, I, NAME, VALUE	FILE, F, I, NAME, I, VALUE, I
2015-05-20, 13:55:47, 0000016170, 1, 7000, PV, IN, 1, 229140E+02	7000, PV, IN, 1, 000000E+00
2015-05-20, 13:55:48, 0000016170, 1, 7000, PV, IN, 1, 229140E+02	7000, PV, IN, 1, 000000E+00
2015-05-20, 13:55:49, 0000016180, 1, 7000, PV, IN, 1, 229140E+02	7000, PV, IN, 1, 000000E+00
2015-05-20, 13:55:50, 0000016181, 1, 7000, PV, IN, 1, 229202E+02	7000, PV, IN, 1, 000000E+00
2015-05-20, 13:55:51, 0000016182, 1, 7000, PV, IN, 1, 229140E+02	7000, PV, IN, 1, 000000E+00
2015-05-20, 13:55:52, 0000016183, 1, 7000, PV, IN, 1, 229133E+02	7000, PV, IN, 1, 000000E+00
2015-05-20, 13:55:53, 0000016184, 1, 7000, PV, IN, 1, 229140E+02	7000, PV, IN, 1, 000000E+00
2015-05-20, 13:55:54, 0000016185, 1, 7000, PV, IN, 1, 229782E+02	7000, PV, IN, 1, 000000E+00
2015-05-20, 13:55:55, 0000016186, 1, 7000, PV, IN, 1, 229871E+02	7000, PV, IN, 1, 000000E+00
2015-05-20, 13:55:56, 0000016187, 1, 7000, PV, IN, 1, 229061E+02	7000, PV, IN, 1, 000000E+00
2015-05-20, 13:55:57, 0000016188, 1, 7000, PV, IN, 1, 229100E+02	7000, PV, IN, 1, 000000E+00
2015-05-20, 13:55:58, 0000016189, 1, 7000, PV, IN, 1, 229396E+02	7000, PV, IN, 1, 000000E+00
2015-05-20, 13:55:59, 0000016190, 1, 7000, PV, IN, 1, 229343E+02	7000, PV, IN, 1, 000000E+00
2015-05-20, 13:56:00, 0000016191, 1, 7000, PV, IN, 1, 229967E+02	7000, PV, IN, 1, 000000E+00
2015-05-20, 13:56:01, 0000016192, 1, 7000, PV, IN, 1, 229279E+02	7000, PV, IN, 1, 000000E+00
2015-05-20, 13:56:02, 0000016193, 1, 7000, PV, IN, 1, 229955E+02	7000, PV, IN, 1, 000000E+00
2015-05-20, 13:56:03, 0000016194, 1, 7000, PV, IN, 1, 229140E+02	7000, PV, IN, 1, 000000E+00
2015-05-20, 13:56:04, 0000016195, 1, 7000, PV, IN, 1, 229153E+02	7000, PV, IN, 1, 000000E+00
2015-05-20, 13:56:05, 0000016196, 1, 7000, PV, IN, 1, 229140E+02	7000, PV, IN, 1, 000000E+00
2015-05-20, 13:56:06, 0000016197, 1, 7000, PV, IN, 1, 229140E+02	7000, PV, IN, 1, 000000E+00
2015-05-20, 13:56:07, 0000016198, 1, 7000, PV, IN, 1, 229140E+02	7000, PV, IN, 1, 000000E+00
2015-05-20, 13:56:08, 0000016199, 1, 7000, PV, IN, 1, 229140E+02	7000, PV, IN, 1, 000000E+00
2015-05-20, 13:56:09, 0000016200, 1, 7000, PV, IN, 1, 229294E+02	7000, PV, IN, 1, 000000E+00
2015-05-20, 13:56:10, 0000016201, 1, 7000, PV, IN, 1, 229294E+02	7000, PV, IN, 1, 000000E+00
2015-05-20, 13:56:11, 0000016202, 1, 7000, PV, IN, 1, 229294E+02	7000, PV, IN, 1, 000000E+00

Fig.31. An example of the archive data file

The fields in the line describing the record have the following meanings:

- date – date of data recording, date separator is the character „-“
- time – hour, minute, second of recorded data, a separator is the character „:“
- record index – unique index record. Each record has a unique number. This number increases when writing new records.
- block – the group number from which recorded data are copied from (1-group 1, 2-group 2, 3-group 3)
- register1 – Modbus register address of the first archived value
- name1 – Modbus register description of the first archived value
- value1 – first archived value. The decimal separator is „.” or „,“, the values are saved in a engineering notation format.
- 
- 
- 
- 
- 
- register10 – Modbus register address of the tenth archived value
- name10 – Modbus register description of the tenth archived value
- value10 – tenth archived value. The decimal separator is „.” or „,“, the values are saved in a engineering notation format.

*name1 ... name10 correspond to the values as follows:*

PV\_IN1 - measuring value at input 1







PV\_IN2 - measuring value at input 2



PV\_IN3 - measuring value at input 3  
PV\_CH1 - measuring value in loop 1  
SP\_CH1 - set point in loop 1  
Y1\_CH1 - loop 1 control signal in loop 1  
Y2\_CH1 - loop 2 control signal in loop 1  
PV\_CH2 - measuring value in loop 2  
SP\_CH2 - Set point in loop 2  
Y1\_CH2 - loop 1 control signal in loop 2  
Y2\_CH2 - loop 2 control signal in loop 2  
MD\_IN1 - value from interface input 1  
MD\_IN2 - value from interface input 2  
M1\_V1 - value 1 from modbus master 1  
M1\_V2 - value 2 from modbus master 1  
M1\_V3 - value 3 from modbus master 1  
M1\_V4 - value 4 from modbus master 1  
M1\_V5 - value 5 from modbus master 1  
M1\_V6 - value 6 from modbus master 1  
M1\_V7 - value 7 from modbus master 1  
M1\_V8 - value 8 from modbus master 1  
M1\_V9 - value 9 from modbus master 1  
M1\_V10 - value 10 from modbus master 1  
M2\_V1 - value 1 from modbus master 2  
M2\_V2 - value 2 from modbus master 2  
M2\_V3 - value 3 from modbus master 2  
M2\_V4 - value 4 from modbus master 2  
M2\_V5 - value 5 from modbus master 2  
M2\_V6 - value 6 from modbus master 2  
M2\_V7 - value 7 from modbus master 2  
M2\_V8 - value 8 from modbus master 2  
M2\_V9 - value 9 from modbus master 2  
M2\_V10 - value 10 from modbus master 2

## 12.5. Status bar of the archiving

Registration status bar indicates the current state of the archiving as well as the status of the SD card inserted in the controller.

Icon	Icon color	Comments
	Current state of the archiving <b>Black</b> – archiving in a group enabled, waiting for the archiving conditions to be met. <b>Red</b> – the archiving conditions have been met and saving the records is in progress. <b>White</b> – archiving in a group disabled	1 – 1 archiving group 2 – 2 archiving group 3 – 3 archiving group
	<b>Black</b> – card installed correctly	
	<b>Red</b> – card installed correctly but other error has occurred	Check if the card is not write-protected
	<b>Black</b> – other error of the card	Check if the SD card is in the adapter.
	<b>Red</b> – wrong file system of the card	Format the card as FAT32.
	<b>Black</b> – Writing to SD card is unblocked	The icon appears only when 
	<b>Black</b> – Writing to SD card blocked	Unlock the write-protection switch on the SD card
	<b>Black</b> – Copying the records from the internal memory to SD card	

1%	The percentage fill SD card	
	<b>Green background</b>	Value in the range 0...70%
	<b>Orange background</b>	70% of SD card space is full. It is recommended to delete unnecessary files.
	<b>Red background</b>	It is less than 70 MB of free space on the SD card left. Immediately delete any unnecessary files or replace the card with another one.

## 12.6. Downloading archive files

Archive files can be downloaded in three different ways:

1. By copying archive files directly from the SD card removed from the controller.
2. Via FTP server -> see section 14. FTP Server.
3. Via the web server -> see section 15. Web Server

## 13. MODBUS PROTOCOL

---

### 13.1. Introduction

RE92 controller is equipped with two RS-485 serial interfaces, one Slave, the second Master or optionally with Ethernet interface with implemented MODBUS Slave protocol.

### 13.2. Modbus master

RS-485 master interface of the controller (connectors 13-12-11) operates in Master mode and can query one or two slave devices connected to it. All devices must have the same communication parameters (see Modbus master → Settings).

Before master mode is enabled, the following parameters must be configured: Modbus master menu → Settings

No		
1	Baud rate	Baud rate
2	Mode	Transmission mode on the connector
3	Times of silence between frames	Times of silence between frames of Modbus protocol

Modbus master menu → Master 1 or Master 2:

No.	Master 1 / Master 2	
1	Address	Address of queried device
2	Operating mode	Manual / Automatic (from template) configuration of the read values from the queried device

3	Template	If you select a template, select the device to be queried from the list
4	Base register	Base register number
5	Number of registers	Number of queried registers
6	Register type	Type of queried registers
7	Interval	Time of query [ms]
8	Max. response time	Maximum response time [ms]
9	Master response function	Function selection for Master mode (0x03 or 0x04)
10	Max. cycles no.	Number of repeated queries in the absence of response

All parameters can also be configured through RS-485 slave.

Master 1 or master 2 is switched on by setting Modbus master menu → Master 1 / Master 2 → Act. or by typing the value of „1” into register 5048 (master 1) or 5070 (master 2).

All values read in Master mode are projected at floating point values and placed in the controller in registers 5200 ... 5218 (Master 1), 5220 ... 5238 (Master 2), the first read value is placed in the register 5200/5220, the second in register 5202/5222, etc.

In Modbus master menu → Master1 / Master 2 of the controller there is a parameter „Maximum number of cycles” which defines the admissible number of incorrect answers to the controller’s query (number of repeated queries before the error is displayed).

The values read by master 1 / Master 2 can be used in the controller loops as a measured value or setpoint value (see section „10. Loop configuration”, and section. „8.4. Interface inputs 1, 2”) or as values for archiving (see section. „12. Archiving”).

## 13.3. Modbus Slave

Summary of the RE92 controller Modbus protocol:

- device address: 1..247,
- baud rate: 4800, 9600, 19200, 38400, 57600 bit/s, 115200 bit/s
- operation modes: RTU,
- mode: 8N2, 8E1, 8O1, 8N1,
- maximum response time: 500 ms,
- data format: float (2x16 bits),
- maximum number of registers read/written in one command: 126.

In case of Modbus TCP slave, the parameters such as device address, baud rate, operating mode, information unit, maximal response time are not used. Additionally a port is set by default at 502.

Registers addresses are identical for Modbus slave and Modbus TCP slave.

RE92 controller uses following protocol functions:

Table 6

Code	Meaning
3	n-registers read
6	1 register write
16	n-registers write
17	slave device identification

### 13.3.1. Error codes

If the controller receives query with the transmission error or checksum error, then such query will be ignored. When a query with correct syntax and invalid values is found, the controller returns an error code.

Table 7 shows error codes and their meaning.

Error codes

Table 7

Code	Meaning	Cause
01	illegal function	function is not handled by the controller
02	illegal data address	register address out of range
03	illegal data value	register value out of range or register is readout only

### 13.3.2. Register map

Register groups map

Table 8

Address range	Value type	Description
4000 – 4469	integer (16 bits)	value set in the 16-bit register
5000 – 5099	float (2x16 bits)	value set in the two subsequent 16-bit registers; readout and write registers
5200 – 5299	float (2x16 bits)	value set in the two subsequent 16-bit registers; readout only registers
6000 – 6223	float (2x16 bits)	value set in the two subsequent 16-bit registers; readout only registers
7000 – 7099	float (2x16 bits)	value set in the two subsequent 16-bit registers, readout only registers
7100 – 7599	float (2x16 bits)	value set in the two subsequent 16-bit registers, readout and write registers
7600 – 21338	float (2x16 bits)	value set in the two subsequent 16-bit registers, readout and write registers

<b>Register address</b>	<b>Marking</b>	<b>Operations</b>	<b>Parameter range</b>	<b>Description</b>
4000		-W	1...11	Command register 1 – switch to manual operation in loop 1 2 – switch to manual operation in loop 2 3 – switch from manual operation to automatic control in loop 1 4 – switch from manual operation to automatic control in loop 2 5 – start auto-tuning in loop 1 6 – start auto-tuning in loop 2 7 – stop auto-tuning in loop 1 8 – stop auto-tuning in loop 2 9 – alarm reset 10 – revert to default settings (with exception of Ethernet group and defined programs) 11 – revert defined programs to default settings
4001		R-	100...999	Loader version number [x100]
4002		R-	10000...65000	Loader version number [x10000]



4003		R-		<p>Controller manufacture code</p> <p>bit 1 0 – INPUT 3:  0 0 – input 3 – none  1 0 – output 3 – current  0/4–20 mA  1 1 – output 3 – voltage  0–10 V</p> <p>bit 3 2 – OUTPUT 1 and 2:  0 1 – output 1 and 2 – relay  1 0 – output 1 and 2 – 0/5 V</p> <p>bit 4 – ANALOG OUTPUTS  0 0 – analog output - none  0 1 – analog output - 2</p>
4004		R-	0...0xFFFF	Controller status – description in table 10
4005		R-	0...0xFFFF	Alarm status – description in table 11
4006		R-	0...0xFFFF	Error status – description in table 12
4007		RW	-1000...1000	Controlling signal from loop 1 [x10] (for writing during manual operation)
4008		RW	-1000...1000	Controlling signal from loop 2 [x10] (for writing during manual operation)
4009		RW	0...2359	Current time – format: hour * 100 + minutes
4010		RW	0...59	Current time – seconds
4011		RW	101...1231	Current date – format: month * 100 + day
4012		RW	2000...2099	Current date – year
4013		R-	1201...9999	Serial number (older part)
4014		R-	1...9999	Serial number (younger part)
4015		R-	0...0x7FFF	Status of timer 1...3 (see Tab.13)

4016		R-	0...0x7FFF	Status of timer 4...6 (see Tab.14)
4017		RW	0...1	Switching off/on the timer 1 0 – timer off 1 – timer on
4018		RW	0...1	Switching off/on the timer 2 0 – timer off 1 – timer on
4019		RW	0...1	Switching off/on the timer 3 0 – timer off 1 – timer on
4020		RW	0...1	Switching off/on the timer 4 0 – timer off 1 – timer on
4021		RW	0...1	Switching off/on the timer 5 0 – timer off 1 – timer on
4022		RW	0...1	Switching off/on the timer 6 0 – timer off 1 – timer on
4023		RW	0...1	Latch type of the timer 1 output 0 – continuous latch 1 – timer latch
4024		RW	0...1	Latch type of the timer 2 output 0 – continuous latch 1 – timer latch
4025		RW	0...1	Latch type of the timer 3 output 0 – continuous latch 1 – timer latch
4026		RW	0...1	Latch type of the timer 4 output 0 – continuous latch 1 – timer latch
4027		RW	0...1	Latch type of the timer 5 output 0 – continuous latch 1 – timer latch
4028		RW	0...1	Latch type of the timer 6 output 0 – continuous latch 1 – timer latch

4029		RW	0...1	Alarm type of timer 1 0 – absolute upper 1 – absolute lower
4030		RW	0...1	Alarm type of timer 2 0 – absolute upper 1 – absolute lower
4031		RW	0...1	Alarm type of timer 3 0 – absolute upper 1 – absolute lower
4032		RW	0...1	Alarm type of timer 4 0 – absolute upper 1 – absolute lower
4033		RW	0...1	Alarm type of timer 5 0 – absolute upper 1 – absolute lower
4034		RW	0...1	Alarm type of timer 6 0 – absolute upper 1 – absolute lower
4035		R-		Archiving status – description in the table 15
4036		R-		Percentage of SD card space used
4037		RW	0...1	Copy the archive to SD card 0 – no activity 1 – all the new records on the SD card (only those records are copied which have been registered since the last copy on the SD card)
4038		RW	0...1	Deleting the entire archive
4039		RW	0...1	Enabling only archiving in the archiving group 1 0 – disabling archiving 1 – enabling archiving
4040		RW	0...1	Enabling only archiving in the archiving group 2 0 – disabling archiving 1 – enabling archiving

4041		RW	0...1	Enabling only archiving in the archiving group 3 0 – disabling archiving 1 – enabling archiving
4042		RW	0...6	Archiving type in the archiving group 1 0 – Interval: archiving at a defined time interval 1 - Absolute upper: archiving at the interval after exceeding the upper threshold set by absolute SP 2 - Absolute lower: archiving at the interval after exceeding the lower threshold set by absolute SP 3 - Relative upper: archiving at the interval after exceeding the upper relative threshold 4 - Relative lower: archiving at the interval after exceeding the lower relative threshold 5 - Relative internal: archiving at the interval within the limits of relative 6 - Relative external: archiving at the interval outside the limits of relative
4043		RW	0...6	Archiving type in the archiving group 2 as for 4042
4044		RW	0...6	Archiving type in the archiving group 3 as for 4042

4045		RW	0...32	<p>The parameter triggering the threshold archiving in archiving group 1</p> <p>0 – PV_Inp1: measuring value at input 1</p> <p>1 – PV_Inp2: measuring value at input 2</p> <p>2 – PV_Inp3: measuring value at input 3</p> <p>3 – PV_Loop 1: measuring value in loop 1</p> <p>4 – SP_Loop 1: set point for loop 1</p> <p>5 – CTRL1_Loop 1: control loop 1 control signal at loop 1</p> <p>6 – CTRL2_Loop 1: control loop 2 control signal at loop 1</p> <p>7 – PV_Loop 2: measuring value in loop 2</p> <p>8 – SP_Loop 2: set point for loop 2</p> <p>9 – CTRL1_Loop 2: loop 1 control signal at loop 2</p> <p>10 – CTRL2_Loop 2:</p> <p>11 – Modbus In1: value from interface input 1</p> <p>12 – Modbus In2: value from interface input 2</p> <p>13 – Master1 Reg1: value 1 from modbus master 1</p> <p>14 – Master1 Reg2: value 2 from modbus master 1</p> <p>15 – Master1 Reg3: value 3 from modbus master 1</p> <p>16 – Master1 Reg4: value 4 from modbus master 1</p> <p>17 – Master1 Reg5: value 5 from modbus master 1</p> <p>18 – Master1 Reg6: value 6 from modbus master 1</p> <p>19 – Master1 Reg7: value 7 from modbus master 1</p> <p>20 – Master1 Reg8: value 8 from modbus master 1</p>
------	--	----	--------	--

				<p>21 – Master1 Reg9: value 9 from modbus master 1</p> <p>22 – Master1 Reg10: value 10 from modbus master 1</p> <p>23 – Master2 Reg1: value 1 from modbus master 2</p> <p>24 – Master2 Reg2: value 2 from modbus master 2</p> <p>25 – Master2 Reg3: value 3 from modbus master 2</p> <p>26 – Master2 Reg4: value 4 from modbus master 2</p> <p>27 – Master2 Reg5: value 5 from modbus master 2</p> <p>28 – Master2 Reg6: value 6 from modbus master 2</p> <p>29 – Master2 Reg7: value 7 from modbus master 2</p> <p>30 – Master2 Reg8: value 8 from modbus master 2</p> <p>31 – Master2 Reg9: value 9 from modbus master 2</p> <p>32 – Master2 Reg10: value 10 from modbus master 2</p>
4046		RW	0...32	The parameter triggering the threshold archiving in archiving group 2 as for 4045
4047		RW	0...32	The parameter triggering the threshold archiving in archiving group 3 as for 4045
4048		RW	0...32	<p>The set point for archiving group 1 with the archiving type: Relative upper, Relative lower, Relative internal, Relative external</p> <p>0 – PV Input1: measuring value at input 1</p> <p>1 – PV Input2: measuring value at input 2</p> <p>2 – PV Input3: measuring value at input 3</p>

3 – PV\_Loop1: measuring value in loop 1  
4 – SP\_Loop1: set point for loop 1  
5 – CTRL1\_Loop1: control loop 1 control signal at loop 1  
6 – CTRL2\_Loop1: control loop 2 control signal at loop 1  
7 – PV\_Loop2: measuring value in loop 2  
8 – SP\_Loop 2: set point for loop 2  
9 – CTRL1\_Loop2: control loop 1 control signal at loop 2  
10 – CTRL2\_Loop2: control loop 2 control signal at loop 2  
11 – In1: value from interface input 1  
12 – Modbus In2: value from interface input 2  
13 – Master1 Reg1: value 1 from modbus master 1  
14 – Master1 Reg2: value 2 from modbus master 1  
15 – Master1 Reg3: value 3 from modbus master 1  
16 – Master1 Reg4: value 4 from modbus master 1  
17 – Master1 Reg5: value 5 from modbus master 1  
18 – Master1 Reg6: value 6 from modbus master 1  
19 – Master1 Reg7: value 7 from modbus master 1  
20 – Master1 Reg8: value 8 from modbus master 1  
21 – Master1 Reg9: value 9 from modbus master 1  
22 – Master1 Reg10: value 10 from modbus master 1  
23 – Master2 Reg1: value 1 from modbus master 2  
24 – Master2 Reg2: value 2 from modbus master 2  
25 – Master2 Reg3: value 3 from modbus master 2  
26 – Master2 Reg4: value 4 from modbus master 2  
27 – Master2 Reg5: value 5 from modbus master 2

				<p>28 – Master2 Reg6: value 6 from modbus master 2</p> <p>29 – Master2 Reg7: value 7 from modbus master 2</p> <p>30 – Master2 Reg8: value 8 from modbus master 2</p> <p>31 – Master2 Reg9: value 9 from modbus master 2</p> <p>32 – Master2 Reg10: value 10 from modbus master 2</p>
4049		RW	0...32	The set point for archiving group 2 with the archiving type: Relative upper, Relative lower, Relative internal, Relative external as for 4048
4050		RW	0...32	The set point for archiving group 3 with the archiving type: Relative upper, Relative lower, Relative internal, Relative external as for 4048
4051		RW	0...2	Field separator of CSV file 0 – Comma: a separator is ',' 1 – Semicolon: a separator is ';' ; 2 – Tab: a separator is a tab character
4052		RW	0...1	Decimal separator of CSV file 0 – Dot: separator of the numbers is the character '.' 1 – Comma: separator of the numbers is the character ','
4053		RW	0...1	Enabling FTP Server 0 – FTP server disabled 1 – FTP server enabled
4054		RW	0...65535	FTP port number
4055		RW	0...1	Enabling Web server 0 – Web server disabled 1 – Web server enabled
4056		RW	80...32000	Web port number
4057		RW	0...1	Interface binary input 1 0 - inactive input 1 - active input



4058		RW	0...1	Interface binary input 2 0 - inactive input 1 - active input
4059		RW	0...1	Interface binary input 3 0 - inactive input 1 - active input
4060		RW	0...1	Control of binary output 1 0 - inactive output 1 - active output
4061		RW	0...1	Control of binary output 2 0 - inactive output 1 - active output
4062		RW	0...1	Control of binary output 3 0 - inactive output 1 - active output
4063		RW	0...1	Control of binary output 4 0 - inactive output 1 - active output
4064		RW	0...1	Control of binary output 5 0 - inactive output 1 - active output
4065		RW	0...1	Control of binary output 6 0 - inactive output 1 - active output
4066		RW	0...65535	character 1 and 2 of loop 1 proper name
4067		RW	0...65535	character 3 and 4 of loop 1 proper name
4068		RW	0...65535	character 5 and 6 of loop 1 proper name
4069		RW	0...65535	character 7 and 8 of loop 1 proper name
4070		RW	0...65535	character 9 and 10 of loop 1 proper name
4071		RW	0...65535	character 1 and 2 of loop 2 proper name

4072		RW	0...65535	character 3 and 4 of loop 2 proper name
4073		RW	0...65535	character 5 and 6 of loop 2 proper name
4074		RW	0...65535	character 7 and 8 of loop 2 proper name
4075		RW	0...65535	character 9 and 10 of loop 2 proper name
4076		RW	0...1	0 - no permission to start the programming control at a given time for channel 1 1 - permission to start the programming control at a given time for channel 1
4077		RW	0...2359	Time of the programming control start at a given time for channel 1 format: hour *100 + minutes
4078		RW	0...59	Seconds of the programming control start at a given time for channel 1
4079		RW	101...1231	Month and day of the programming control start at a given time for channel 1 format: month * 100 + day
4080		RW	2015...2077	Year of the programming control start at a given time for channel 1
4081		RW	0...1	0 - no permission to start the programming control at a given time for channel 2 1 - permission to start the programming control at a given time for channel 2
4082		RW	0...2359	Time of the programming control start at a given time for channel 2 format: hour *100 + minutes

4083		RW	0...59	Seconds of the programming control start at a given time for channel 2
4084		RW	101...1231	Month and day of the programming control start at a given time for channel 2 format: month * 100 + day
4085		RW	2015...2077	Year of the programming control start at a given time for channel 2
4086		RW	0...65535	character 1 and 2 of the value name screen 1
4087		RW	0...65535	character 3 and 4 of the value name screen 1
4088		RW	0...65535	character 5 and 6 of the value name screen 1
4089		RW	0...65535	character 7 and 8 of the value name screen 1
4090		RW	0...65535	character 10 and 10 of the value name screen 1
4091		RW	0...65535	character 11 and 12 of the value name screen 1
4092		RW	0...5	Color of value 1, screen 1 0 - Green 1 - Red 2 - Yellow 3 - White 4 - Blue 5 - Purple
4093		RW	0...1	Selection of unit, value 1, screen 1 0 - From the table 1 - Manual entry

4094		RW	0...20	Unit, value 1, screen 1 0 - °C, 1 - °F, 2 - PU, 3 - %, 4 - %RH, 5 - g/m <sup>3</sup> , 6 - g/kg, 7 - kJ/kg, 8 - at, 9 - Pa, 10 - hPa, 11 - kPa, 12 - MPa, 13 - mmHg, 14 - bar, 15 - cmHg, 16 - inHg, 17 - kp/cm <sup>2</sup> , 18 - m <sup>2</sup> , 19 - m <sup>3</sup> , 20 - ug/m <sup>3</sup>
4095		RW	0...65535	character 1 and 2 value 1 unit name screen 1
4096		RW	0...65535	character 3 and 4 value 1 unit name screen 1
4097		RW	0...65535	character 5 and 6 value 1 unit name screen 1
4098		RW	0...5	Alarm type, value 1, screen 1 0 - Above the threshold 1 - Below the threshold 2 - Between the thresholds 3 - Outside the thresholds 4 - Manually switched on 5 - Manually switched off
4099		RW	0...3600 s	Alarm signaling delay, value 1, screen 1
4100		RW	0...1	Alarm signaling upholding, value 1, screen 1 0 - Off 1 - On
4101		RW	0...1	Alarm occurrence signaling, value 1, screen 1 0 - continuous 1 - Flashing

4102		RW	0...6	Color below the lower alarm threshold, value 1, screen 1 0 - Black 1 - Green 2 - Red 3 - Yellow 4 - White 5 - Blue 6 - Purple
4103		RW	0...6	Color above the lower alarm threshold, value 1, screen 1 0 - Black 1 - Green 2 - Red 3 - Yellow 4 - White 5 - Blue 6 - Purple
4104		RW	0...65535	Register number, value 1, screen 1
4105		RW	0...4	Decimal point, value 1, screen 1 0 - DP0 1 - DP1 2 - DP2 3 - DP3 4 - DP4
4106		RW	0...1	Rescaling values, values 1, screen 1 0 - off 1 - on
4107-4127		RW		Value 2, screen 1 The scope of changes is similar to the registers 4086 - 4106
4128-4148		RW		Value 3, screen 1 The scope of changes is similar to the registers 4086 - 4106
4149-4169		RW		Value 4, screen 1 The scope of changes is similar to the registers 4086 - 4106

4170-4190		RW		Value 5, screen 1 The scope of changes is similar to the registers 4086 - 4106
4191-4211		RW		Value 6, screen 1 The scope of changes is similar to the registers 4086 - 4106
4212-4232		RW		Value 1, screen 2 The scope of changes is similar to the registers 4086 - 4106
4233-4253		RW		Value 2, screen 2 The scope of changes is similar to the registers 4086 - 4106
4254-4274		RW		Value 3, screen 2 The scope of changes is similar to the registers 4086 - 4106
4275-4295		RW		Value 4, screen 2 The scope of changes is similar to the registers 4086 - 4106
4296-4216		RW		Value 5, screen 2 The scope of changes is similar to the registers 4086 - 4106
4317-4337		RW		Value 6, screen 2 The scope of changes is similar to the registers 4086 - 4106
4338-4358		RW		Value 1, screen 3 The scope of changes is similar to the registers 4086 - 4106
4359-4379		RW		Value 2, screen 3 The scope of changes is similar to the registers 4086 - 4106
4380-4400		RW		Value 3, screen 3 The scope of changes is similar to the registers 4086 - 4106
4401-4421		RW		Value 4, screen 3 The scope of changes is similar to the registers 4086 - 4106

4422-4442		RW		Value 5, screen 3 The scope of changes is similar to the registers 4086 - 4106
4443-4463		RW		Value 6, screen 3 The scope of changes is similar to the registers 4086 - 4106
4464		RW	0x0000... ...0x003F	List of values to display on screen 1 0x0001 - Value 1 0x0002 - Value 2 0x0004 - Value 3 0x0008 - Value 4 0x0010 - Value 5 0x0020 - Value 6
4465		RW	0x0000... ...0x003F	List of values to display on screen 2 0x0001 - Value 1 0x0002 - Value 2 0x0004 - Value 3 0x0008 - Value 4 0x0010 - Value 5 0x0020 - Value 6
4466		RW	0x0000... ...0x003F	List of values to display on screen 3 0x0001 - Value 1 0x0002 - Value 2 0x0004 - Value 3 0x0008 - Value 4 0x0010 - Value 5 0x0020 - Value 6
4467		R	-	Visual alarm status, screen 1
4468		R	-	Visual alarm status, screen 2
4469		R	-	Visual alarm status, screen 3
4470		RW	0...1	Resetting of signaling upholding for all alarms for 1 screen with values 0 - no operation 1 - indicators reset

4471		RW	0...1	Resetting of signaling upholding for all alarms for 2 screen with values 0 - no operation 1 – indicators reset
4472		RW	0...1	Resetting of signaling upholding for all alarms for 3 screen with values 0 - no operation 1 – indicators reset

Register 4004 – controller status

Table 10

bit	Description
0	Input 1 measuring value out of measurement range
1	Input 2 measuring value out of measurement range
2	Input 3 measuring value out of measurement range
3	Loop 1 measuring value out of measurement range
4	Loop 2 measuring value out of measurement range
5	Manual operation in loop 1: 1 – active, 0 – inactive
6	Manual operation in loop 2: 1 – active, 0 – inactive
7	Auto-tuning in loop 1: 1 – active, 0 – inactive
8	Auto-tuning in loop 2: 1 – active, 0 – inactive
9	Auto-tuning in loop 1 failed
10	Auto-tuning in loop 2 failed
11	Soft start in loop 1: 1 – active, 0 – inactive
12	Soft start in loop 2: 1 – active, 0 – inactive
13-14	Reserved
15	Controller error – check the error register



bit	Description
0	State of the alarm 1.:1 – active, 0 – inactive
1	Status of the alarm 2.:1 – active, 0 – inactive
2	Status of the alarm 3.:1 – active, 0 – inactive
3	Status of the alarm 4.:1 – active, 0 – inactive
4	Status of the alarm 5.:1 – active, 0 – inactive
5	Status of the alarm 6.:1 – active, 0 – inactive
6	Status of binary input 1 (terminal 2 of controller connector): 1 - terminal 2 shorted to terminal 1
7	Status of binary input 2 (terminal 3 of controller connector): 1 - terminal 3 shorted to terminal 1
8	Status of binary input 3 (terminal 4 of controller connector): 1 - terminal 4 shorted to terminal 1
9	Status of binary output 1: 1 - active output, 0 - inactive output
10	Status of binary output 2: 1 - active output, 0 - inactive output
11	Status of binary output 3: 1 - active output, 0 - inactive output
12	Status of binary output 4: 1 - active output, 0 - inactive output
13	Status of binary output 5: 1 - active output, 0 - inactive output
14	Status of binary output 6: 1 - active output, 0 - inactive output
15	Reserved

bit	Description
0	Uncalibrated input 1
1	Uncalibrated input 2
2	Uncalibrated input 3
2	Uncalibrated input 1 (current)
3	Uncalibrated input 1 (voltage)
4	Uncalibrated input 2 (current)
5	Uncalibrated input 2 (voltage)
6-14	Reserved
15	Controller memory checksum error

Register 4015 – status of the timers 1..3

Table 13

bit	Description
4...0	Timer 1 bxxxxxxxxxxxx00000 – other statuses bxxxxxxxxxxxx00001 – timer enabled waiting for event bxxxxxxxxxxxx00010 – countdown bxxxxxxxxxxxx00100 – timer pause bxxxxxxxxxxxx01000 – end of the countdown bxxxxxxxxxxxx10000 – alarm timer on (output actuated)
9...5	Timer 2 bxxxxxx00000xxxxx – other statuses bxxxxxx00001xxxxx – timer enabled waiting for event bxxxxxx00010xxxxx – countdown bxxxxxx00100xxxxx – timer pause bxxxxxx01000xxxxx – end of the countdown bxxxxxx10000xxxxx – alarm timer on (output actuated)
14...10	Timer 3 bx00000xxxxxxxxxxx – other statuses bx00001xxxxxxxxxxx – timer enabled waiting for event bx00010xxxxxxxxxxx – countdown bx00100xxxxxxxxxxx – timer pause bx01000xxxxxxxxxxx – end of the countdown bx10000xxxxxxxxxxx – alarm timer on (output actuated)
15	Reserved

Register 4016 – status of the timers 4..6

Table 14

bit	Description
4...0	Timer 4 bxxxxxxxxxxxx00000 – other statuses bxxxxxxxxxxxx00001 – timer enabled waiting for event bxxxxxxxxxxxx00010 – countdown bxxxxxxxxxxxx00100 – timer pause bxxxxxxxxxxxx01000 – end of the countdown bxxxxxxxxxxxx10000 – alarm timer on (output actuated)

9...5	<p>Timer 5</p> <p>bxxxxxx00000xxxxx – other statuses</p> <p>bxxxxxx00001xxxxx – timer enabled waiting for event</p> <p>bxxxxxx00010xxxxx – countdown</p> <p>bxxxxxx00100xxxxx – timer pause</p> <p>bxxxxxx01000xxxxx – end of the countdown</p> <p>bxxxxxx10000xxxxx – alarm timer on (output actuated)</p>
14...10	<p>Timer 6</p> <p>bx00000xxxxxxxxxxx – other statuses</p> <p>bx00001xxxxxxxxxxx – timer enabled waiting for event</p> <p>bx00010xxxxxxxxxxx – countdown</p> <p>bx00100xxxxxxxxxxx – timer pause</p> <p>bx01000xxxxxxxxxxx – end of the countdown</p> <p>bx10000xxxxxxxxxxx – alarm timer on (output actuated)</p>
15	Reserved

Map of the registers from address 7000

Table 15

Register address	Operations	Description
7000	R	Measuring value at input 1
7002	R	Measuring value at input 2
7004	R	Measuring value at input 3
7006	R	Measuring value in loop 1
7008	R	Set point value in loop 1
7010	R	Loop 1 controlling signal in loop 1
7012	R	Loop 2 controlling signal in loop 1
7014	R	Measuring value in loop 2
7016	R	Set point value in loop 2
7018	R	Loop 1 controlling signal in loop 2
7020	R	Loop 2 controlling signal in loop 2

7058	R	Time to switch on the alarm timer 1
7060	R	Time to switch on the alarm timer 2
7062	R	Time to switch on the alarm timer 3
7064	R	Time to switch on the alarm timer 4
7066	R	Time to switch on the alarm timer 5
7068	R	Time to switch on the alarm timer 6
7070	R	Time to switch off the alarm timer 1 latch
7072	R	Time to switch off the alarm timer 2 latch
7074	R	Time to switch off the alarm timer 3 latch
7076	R	Time to switch off the alarm timer 4 latch
7078	R	Time to switch off the alarm timer 5 latch
7080	R	Time to switch off the alarm timer 6 latch

Register 4467 - Visual alarm status, screen 1

Register 4468 - Visual alarm status, screen 2

Register 4469 - Visual alarm status, screen 3

Table 16

Bit	Description
0	0 - No visual alarm signaling for value 1, 1 - Visual alarm signaling for value 1
1	0 - No visual alarm signaling for value 1, 1 - Visual alarm signaling for value 2
2	0 - No visual alarm signaling for value 1, 1 - Visual alarm signaling for value 3
3	0 - No visual alarm signaling for value 1, 1 - Visual alarm signaling for value 4
4	0 - No visual alarm signaling for value 1, 1 - Visual alarm signaling for value 5
5	0 - No visual alarm signaling for value 1, 1 - Visual alarm signaling for value 6
6	Reserved

7	Reserved
8	0 - No signaling after alarm discontinuation for value 1, 1 - Signaling after alarm discontinuation for value 1,
9	0 - No signaling after alarm discontinuation for value 2, 1 - Signaling after alarm discontinuation for value 2,
10	0 - No signaling after alarm discontinuation for value 3, 1 - Signaling after alarm discontinuation for value 3,
11	0 - No signaling after alarm discontinuation for value 4, 1 - Signaling after alarm discontinuation for value 4,
12	0 - No signaling after alarm discontinuation for value 5, 1 - Signaling after alarm discontinuation for value 5,
13	0 - No signaling after alarm discontinuation for value 6, 1 - Signaling after alarm discontinuation for value 6,
14	Reserved
15	Reserved

Map of the registers from address 5000

Table 17

register address	marking	operations	parameter range	description
5000		RW	0...1	Assignment for interface input 1 0 – master 1 1 – master 2
5002		RW	0...9	Value number for interface input 1 from list of 10 values read with function modbus master
5004		RW	0...4	Unit of interface input 1 0 - °C : degree Celsius 1 - °F : degrees Fahrenheit 2 - PU: physical units 3 - %: percentage 4 - %RH: relative humidity,

5006		RW	0...2	Position of decimal place of interface input 1 0 - DP0 : without decimal place 1 - DP1 : 1 decimal place 2 - DP2 : 2 decimal places
5008		RW	-35...35	Interface input 1 value shift (value selected in register 5002)
5010		RW	0...9	Digital filter of interface input 1: 0 - filter off 1- time constant 0.2 s 2- time constant 0.5 s 3- time constant 1 s 4- time constant 2 s 5- time constant 5 s 6- time constant 10 s 7- time constant 20 s 8- time constant 50 s 9- time constant 100 s
5012		RW	0...1	Assignment for interface input 2 0 – master 1 1 – master 2
5014		RW	0...9	Value number for interface input 2 from list of 10 values read with function modbus master
5016		RW	0...4	Unit of interface input 2 0 - °C : degree Celsius 1 - °F : degrees Fahrenheit 2 - PU: physical units 3 - %: percentage 4 - %RH: relative humidity,
5018		RW	0...2	Position of decimal place of interface input 2 0 - DP0 : without decimal place 1 - DP1 : 1 decimal place 2 - DP2 : 2 decimal places
5020		RW	-35...35	Interface input 2 value shift (value selected in register 5014)

5022		RW	0...9	Digital filter of interface input 2: 0 - filter off 1- time constant 0.2 s 2- time constant 0.5 s 3- time constant 1 s 4- time constant 2 s 5- time constant 5 s 6- time constant 10 s 7- time constant 20 s 8- time constant 50 s 9- time constant 100 s
5024	Reserved			
5026	Reserved			
5028	Reserved			
5030	Reserved			
5032	Reserved			
5034	Reserved			
5036		RW	0... 0x00080000	List of modbus master parameters selected for archiving in archiving group 1 0x00000001 - M1_V1 : value 1 from modbus master 1 0x00000002 - M1_V2 : value 2 from modbus master 1 0x00000004 - M1_V3 : value 3 from modbus master 1 0x00000008 - M1_V4 : value 4 from modbus master 1 0x00000010 - M1_V5 : value 5 from modbus master 1 0x00000020 - M1_V6 : value 6 from modbus master 1 0x00000040 - M1_V7 : value 7 from modbus master 1 0x00000080 - M1_V8 : value 8 from modbus master 1 0x00000100 - M1_V9 : value 9 from modbus master 1



			<p>0x00000200 - M1_V10 : value 10 from modbus master 1</p> <p>0x00000400 - M2_V1 : value 1 from modbus master 2</p> <p>0x00000800 - M2_V2 : value 2 from modbus master 2</p> <p>0x00001000 - M2_V3 : value 3 from modbus master 2</p> <p>0x00002000 - M2_V4 : value 4 from modbus master 2</p> <p>0x00004000 - M2_V5 : value 5 from modbus master 2</p> <p>0x00008000 - M2_V6 :value 6 from modbus master 2</p> <p>0x00010000 - M2_V7 : value 7 from modbus master 2</p> <p>0x00020000 - M2_V8 : value 8 from modbus master 2</p> <p>0x00040000 - M2_V9 : value 9 from modbus master 2</p> <p>0x00080000 - M2_V10 : value 10 from modbus master 2</p>
5038	RW	0... 0x00080000	List of modbus master parameters selected for archiving in archiving group 2 (as per register 5036)
5040	RW	0... 0x00080000	List of modbus master parameters selected for archiving in archiving group 3 (as per register 5036)
5042	RW	0...5	<p>Baud rate of modbus master</p> <p>0 - 4800 bps</p> <p>1 - 9600 bps</p> <p>2 - 19.2k bps</p> <p>3 - 38.4k bps</p> <p>4 - 57.6k bps</p> <p>5 - 115.2k bps</p>
5044	RW	0...3	<p>Transmission protocol of modbus master</p> <p>0 - RTU 8N2</p> <p>1 - RTU 8E1</p> <p>2 - RTU 8O1</p> <p>3 - RTU 8N1</p>

5046		RW	100...5000 [ms]	Times of silence between frames of Modbus protocol
5048		RW	0...1	Modbus Master 1 0 - Disabled 1 - Enabled
5050		RW	1...247	Address of modbus master 1
5052		RW	0...1	Operating mode of modbus master 1 <b>0 - Manual</b> (to be configured manually: „Base Register”, „Value Number” and „Value Type”) <b>1 - Template</b> (value readout from device indicated in „Template”)
5054		RW	0...65535	Base register of modbus master 1
5056		RW	1...10	Number of registers of modbus master 1
5058		RW	0...12	Register type of modbus master 1 <b>0 - char 8:</b> char register (8 bits with character) <b>1 - uchar 8:</b> unsigned char register (8 bits without character) <b>2 - short 16:</b> short register (16 bits with character) <b>3 - ushort 16:</b> unsigned short register (16 bits without character) <b>4 - long 32:</b> long register (32 bits with character) <b>5 - ulong 32:</b> unsigned long register (32 bits without character) <b>6 - float 32:</b> float register (32 bits, variable comma with character) <b>7 - sw float 2x16:</b> swapped float register, value set in two 16-bit registers (byte order 3,2,1,0) <b>8 - float 2x16:</b> float register, value set in two 16-bit registers (byte order 1,0,3,2)

			<p><b>9 - long 2x16:</b> long register, value set in two 16-bit registers (32 bits with character, byte order 1,0,3,2)</p> <p><b>10 - sw long 2x16:</b> swapped long register, value set in two 16-bit registers (32 bits with character, byte order 3,2,1,0)</p> <p><b>11 - ulong 2x16:</b> unsigned long register, value set in two 16-bit registers (32 bits without character, byte order 1,0,3,2)</p> <p><b>12 - sw ulong 2x16 :</b> swapped unsigned long register, value set in two 16-bit registers (32 bits without character, byte order 3,2,1,)</p>
5060	RW	0...2	<p>Template of modbus master 1</p> <p><b>0 - P18, P18D, P19</b>  T - register 7501 - measured temperature,  RH - register 7502 - calculated absolute humidity  DP - register 7503 - calculated dew point  AH - register 7504 - calculated absolute humidity</p> <p><b>1 - P30U</b>  DISP VAL1 - register 7505 - displayed value,  MEAS VAL1 - register 7510 - measured value,  DISP VAL2 - register 7512 - second displayed value</p> <p><b>2 - P18S</b>  T - register 7501 - measured temperature,  RH - register 7502 - calculated absolute humidity  DP - register 7503 - calculated dew point  AH - register 7504 - calculated absolute humidity</p>

5062		RW	5...36000 [ms]	Query interval of modbus master 1
5064		RW	100...5000 [ms]	Maximum response time to query frame of modbus master 1
5066		RW	0...1	Function type of modbus master 1 protocol 0 - 0x03: querying with function 0x03 1 - 0x04: querying with function 0x04
5068		RW	0...10	Maximum number of modbus master 1 repetitions Maximum number of repeated queries in absence of response from device
5070		RW	0...1	Modbus Master 2 0 - off 1 - on
5072		RW	1...247	Address of modbus master 2
5074		RW	0...1	Operating mode of modbus master 2 <b>0 - Manual</b> (to be configured manually: „Base Register”, „Value Numer” and „Value Type”) <b>1 - Template</b> (value readout from device indicated in „Template”)
5076		RW	0...65535	Base register of modbus master 2
5078		RW	1...10	Number of registers of modbus master 2
5080		RW	0...12	Register type of modbus master 2 Register type of modbus master 2 <b>0 - char 8:</b> char register (8 bits with character) <b>1- uchar 8:</b> unsigned char register (8 bits without character) <b>2- short 16:</b> short register (16 bits with character) <b>3- ushort 16:</b> unsigned short register (16 bits without character) <b>4- long 32:</b> long register (32 bits with character)

				<p><b>5- ulong 32:</b> unsigned long register (32 bits without character))</p> <p><b>6- float 32:</b> float register (32 bits, variable comma with character)</p> <p><b>7- sw float 2x16:</b> swapped float register, value set in two 16-bit registers (byte order 3,2,1,0)</p> <p><b>8- float 2x16:</b> float register, value set in two 16-bit registers (byte order 1,0,3,2)</p> <p><b>9- long 2x16:</b> long register, value set in two 16-bit registers (32 bits with character, byte order 1,0,3,2)</p> <p><b>10- sw long 2x16:</b> swapped long register, value set in two 16-bit registers (32 bits with character, byte order 3,2,1,0)</p> <p><b>11- ulong 2x16:</b> unsigned long register, value set in two 16-bit registers (32 bits without character, byte order 1,0,3,2)</p> <p><b>12- sw ulong 2x16 :</b> swapped unsigned long register, value set in two 16-bit registers (32 bits without character, byte order 3,2,1,)</p>
5082	RW	0...2	<p>Template of modbus master 2</p> <p><b>0 - P18, P18D, P19</b></p> <p>T - register 7501 - measured temperature,</p> <p>RH - register 7502 - measured relative humidity,</p> <p>DP - register 7503 - calculated dew point</p> <p>AH - register 7504 - calculated absolute humidity</p>	

			<p><b>1 - P30U</b>  DISP VAL1 - register 7505 - displayed value,  MEAS VAL - register 7510 - measured value,  DISP VAL2 - register 7512 - second displayed value</p> <p><b>2 - P18S</b>  T - register 7501 - measured temperature,  RH - register 7502 - calculated absolute humidity  DP - register 7503 - calculated dew point  AH - register 7504 - calculated absolute humidity</p>
5084	RW	5...36000 [ms]	Query interval of modbus master 2
5086	RW	100...5000 [ms]	Maximum response time to query frame of modbus master 2
5088	RW	0...1	Protocol function type of modbus master 2 0 - 0x03: querying with function 0x03 1 - 0x04: querying with function 0x04
5090	RW	0...10	Maximum number of modbus master 2 repetitions Maximum number of repeated queries in absence of response from device

Register address	Operations	Description
5200	R	Value 1 read by modbus master 1
5202	R	Value 2 read by modbus master 1
5204	R	Value 3 read by modbus master 1
5206	R	Value 4 read by modbus master 1
5208	R	Value 5 read by modbus master 1
5210	R	Value 6 read by modbus master 1
5212	R	Value 7 read by modbus master 1
5214	R	Value 8 read by modbus master 1
5216	R	Value 9 read by modbus master 1
5218	R	Value 10 read by modbus master 1
5220	R	Value 1 read by modbus master 2
5222	R	Value 2 read by modbus master 2
5224	R	Value 3 read by modbus master 2
5226	R	Value 4 read by modbus master 2
5228	R	Value 5 read by modbus master 2
5230	R	Value 6 read by modbus master 2
5232	R	Value 7 read by modbus master 2
5234	R	Value 8 read by modbus master 2
5236	R	Value 9 read by modbus master 2
5238	R	Value 10 read by modbus master 2

Register address	operation	Description	
6000	RW	0.0...100.0 [%]	Minimum control signal (set2) in channel 1
6002	RW	0.0...100.0 [%]	Maximum control signal (set2) in channel 1
6004	RW	0.0...100.0 [%]	Minimum control signal (set2) in channel 2
6006	RW	0.0...100.0 [%]	Maximum control signal (set2) in channel 2
Screen 1 with values			
Value 1			
6008	RW	-999999.0... 999999.9	Lower alarm threshold
6010	RW	-999999.0... 999999.9	Upper alarm threshold
6012	RW	-9999.0...9999.9	Lower input value (rescaling values)
6014	RW	-999999.0... 999999.9	Lower output value (rescaling values)
6016	RW	-9999.0...9999.9	Upper input value (rescaling values)
6018	RW	-999999.0... 999999.9	Upper output value (rescaling values)
Value 2			
6020 - 6030	RW		The scope of changes is similar to the registers 6008 - 6018



Value 3			
6032 - 6042	RW		The scope of changes is similar to the registers 6008 - 6018
Value 4			
6044 - 6054	RW		The scope of changes is similar to the registers 6008 - 6018
Value5			
6056 - 6066	RW		The scope of changes is similar to the registers 6008 - 6018
Value 6			
6068 - 6078	RW		The scope of changes is similar to the registers 6008 - 6018
Screen 2 with values			
Value 1			
6080 - 6090	RW		The scope of changes is similar to the registers 6008 - 6018
Value 2			
6092 - 6102	RW		The scope of changes is similar to the registers 6008 - 6018
Value 3			
6104 - 6114	RW		The scope of changes is similar to the registers 6008 - 6018
Value 4			
6116 - 6126	RW		The scope of changes is similar to the registers 6008 - 6018
Value 5			
6128 - 6138	RW		The scope of changes is similar to the registers 6008 - 6018

Value 6			
6140 - 6150	RW		The scope of changes is similar to the registers 6008 - 6018
Screen 3 with values			
Value 1			
6152 - 6162	RW		The scope of changes is similar to the registers 6008 - 6018
Value 2			
6164 - 6174	RW		The scope of changes is similar to the registers 6008 - 6018
Value 3			
6176 - 6186	RW		The scope of changes is similar to the registers 6008 - 6018
Value 4			
6188 - 6198	RW		The scope of changes is similar to the registers 6008 - 6018
Value 5			
6200 - 6210	RW		The scope of changes is similar to the registers 6008 - 6018
Value 6			
6212 - 6222	RW		The scope of changes is similar to the registers 6008 - 6018

Register address	Operations	Description
7000	R	Measuring value at input 1
7002	R	Measuring value at input 2
7004	R	Measuring value at input 3
7006	R	Measuring value in loop 1
7008	R	Set point value in loop 1
7010	R	Loop 1 controlling signal in loop 1
7012	R	Loop 2 controlling signal in loop 1
7014	R	Measuring value in loop 2
7016	R	Set point value in loop 2
7018	R	Loop 1 controlling signal in loop 2
7020	R	Loop 2 controlling signal in loop 2
7058	R	Time to switch on the alarm timer 1
7060	R	Time to switch on the alarm timer 2
7062	R	Time to switch on the alarm timer 3
7064	R	Time to switch on the alarm timer 4
7066	R	Time to switch on the alarm timer 5
7068	R	Time to switch on the alarm timer 6
7070	R	Time to switch off the alarm timer 1 latch
7072	R	Time to switch off the alarm timer 2 latch
7074	R	Time to switch off the alarm timer 3 latch
7076	R	Time to switch off the alarm timer 4 latch

7078	R	Time to switch off the alarm timer 5 latch
7080	R	Time to switch off the alarm timer 6 latch
7082	R	The number of the records to be copied to SD card in archiving group 1
7084	R	The number of the records to be copied to SD card in archiving group 2
7086	R	The number of the records to be copied to SD card in archiving group 3
7088	R	Value from interface input 1
7090	R	Value from interface input 2

Register address	Operations	Parameter range	Description
7100	RW	0...18	Type of input no. 1: 0 – thermoresistor Pt100 1 – thermoresistor Pt500 2 – thermoresistor Pt1000 3 – thermoresistor Ni100 4 – thermoresistor Ni1000 5 – thermoresistor Cu100 6 – J type thermocouple 7 – T type thermocouple 8 – K type thermocouple 9 – S type thermocouple 10 – R type thermocouple 11 – B type thermocouple 12 – E type thermocouple 13 – N type thermocouple 14 – L type thermocouple 15 – current input 0-20 mA 16 – current input 4-20 mA 17 – voltage input 0-5 V 18 – voltage input 0-10 V
7102	RW	0...2	Unit of input no 1: 0 – degrees Celsius 1 – degrees Fahrenheit 2 – physical units
7104	RW	0...1 <sup>3) 4)</sup> 0...2 <sup>5)</sup>	Decimal point position for input 1: 0 – without a decimal place 1 – 1 decimal place 2 – 2 decimal places
7106	RW	0...1	Compensation of thermocouple cold terminals for input 1: 0 – automatic 1 – manual

7108	RW	0...50.0	Cold terminals temperature with manual compensation for input 1
7110	RW	-9999...99999	Indication for the lower limit for input 1 (linear input)
7112	RW	-9999...99999	Indication for the upper limit for input 1 (linear input)
7114	RW	-35.00...35.00	Measured value shift for input 1
7116	RW	0...9	Digital filter of input no 1: 0 – filter off 1 – time constant 0.2 s 2 – time constant 0.5 s 3 – time constant 1 s 4 – time constant 2 s 5 – time constant 5 s 6 – time constant 10 s 7 – time constant 20 s 8 – time constant 50 s 9 – time constant 100 s
7118	RW	0...18	Type of input no. 2: 0 – thermoresistor Pt100 1 – thermoresistor Pt500 2 – thermoresistor Pt1000 3 – thermoresistor Ni100 4 – thermoresistor Ni1000 5 – thermoresistor Cu100 6 – J type thermocouple 7 – T type thermocouple 8 – K type thermocouple 9 – S type thermocouple 10 – R type thermocouple 11 – B type thermocouple 12 – E type thermocouple 13 – N type thermocouple 14 – L type thermocouple 15 – current input 0-20 mA 16 – current input 4-20 mA 17 – voltage input 0-5 V 18 – voltage input 0-10 V

7120	RW	0...2	Unit of input no 2: 0 – degrees Celsius 1 – degrees Fahrenheit 2 – physical units
7122	RW	0...1 <sup>3) 4)</sup> 0...2 <sup>5)</sup>	Decimal point position for input 2: 0 – without a decimal place 1 – 1 decimal place 2 – 2 decimal places
7124	RW	0...1	Compensation of thermocouple cold terminals for input 2: 0 – automatic 1 – manual
7126	RW	0...50.0	Cold terminals temperature with manual compensation for input 2
7128	RW	-9999... 99999	Indication for the lower limit for input 2 (linear input)
7130	RW	-9999... 99999	Indication for the upper limit for input 2 (linear input)
7132	RW	-35.00... 35.00	Measured value shift for input 2
7134	RW	0...9	Digital filter of input no 2: 0 – filter off 1 – time constant 0.2 s 2 – time constant 0.5 s 3 – time constant 1 s 4 – time constant 2 s 5 – time constant 5 s 6 – time constant 10 s 7 – time constant 20 s 8 – time constant 50 s 9 – time constant 100 s
7136	RW	0...6	Type of input no. 3: 0 – none 1 – current input 0-20 mA 2 – current input 4-20 mA 3 – voltage input 0-5 V 4 – voltage input 0-10 V 5 – potentiometric input 100 Ohm 6 – potentiometric input 1000 Ohm

7138	RW	0...2	Unit of input no 3: 0 – degrees Celsius 1 – degrees Fahrenheit 2 – physical units
7140	RW	0...1 <sup>3) 4)</sup> 0...2 <sup>5)</sup>	Decimal point position for input 3: 0 – without a decimal place 1 – 1 decimal place 2 – 2 decimal places
7142	RW	-9999... 99999	Indication for the lower limit for input 3 (linear input)
7144	RW	-9999... 99999	Indication for the upper limit for input 3 (linear input)
7146	RW	-35.00...35.00	Measured value shift for input 3
7148	RW	0...9	Digital filter of input no 3: 0 – filter off 1 – time constant 0.2 s 2 – time constant 0.5 s 3 – time constant 1 s 4 – time constant 2 s 5 – time constant 5 s 6 – time constant 10 s 7 – time constant 20 s 8 – time constant 50 s 9 – time constant 100 s
7150	RW	0...22	Function of binary input 1: 0 – none 1 – stop automatic control 2 – switch to manual operation 3 – switches to subsequent SP SP1<->SP2, SP2<->SP3, SP3<->SP4, SP4<->SP1 4 – program start 5 – jump to the next segment 6 – stops the incrementing of the set value in program 7 – end of the program 8 – stop of the program with possible continuation 9 – stop the program and jump to the beginning 10 – switching to subsequent SP from the additional input - IN3



			<ul style="list-style-type: none"> <li>11 – alarm reset of timer 1</li> <li>12 – alarm reset of timer 2</li> <li>13 – alarm reset of timer 3</li> <li>14 – alarm reset of timer 4</li> <li>15 – alarm reset of timer 5</li> <li>16 – alarm reset of timer 6</li> <li>17 – switching to SP from the input 1</li> <li>18 – switching to SP from the input 2</li> <li>19 – switches to SP from first interface input</li> <li>20 – switches to SP from second interface input</li> <li>21 -switches to subsequent SP:  <ul style="list-style-type: none"> <li>SP1&gt;&gt;SP2&gt;&gt;SP3&gt;&gt;SP4&gt;&gt;</li> <li>SPIN1&gt;&gt;SPIN2&gt;&gt;SPIN3&gt;&gt;</li> <li>SPMd1&gt;&gt; SPMd2&gt;&gt;SP1</li> </ul> </li> <li>22 - switching to the second set of parameters for limiting the control signal</li> </ul>
7152	RW	0...22	<p>Function of binary input 2:</p> <ul style="list-style-type: none"> <li>0 – none</li> <li>1 – stop automatic control</li> <li>2 – switch to manual operation</li> <li>3 – switches to subsequent SP  <ul style="list-style-type: none"> <li>SP1&lt;-&gt;SP2, SP2&lt;-&gt;SP3,</li> <li>SP3&lt;-&gt;SP4, SP4&lt;-&gt;SP1</li> </ul> </li> <li>4 – program start</li> <li>5 – jump to the next segment</li> <li>6 – stops the incrementing of the set value in program</li> <li>7 – end of the program</li> <li>8 – stop of the program with possible continuation</li> <li>9 – stop the program and jump to the beginning</li> <li>10 – switching to subsequent SP from the additional input - IN3</li> <li>11 – alarm reset of timer 1</li> <li>12 – alarm reset of timer 2</li> <li>13 – alarm reset of timer 3</li> <li>14 – alarm reset of timer 4</li> <li>15 – alarm reset of timer 5</li> <li>16 – alarm reset of timer 6</li> <li>17 – switching to SP from the input 1</li> <li>18 – switching to SP from the input 2</li> <li>19 – switches to SP from first interface input</li> </ul>

			<p>20 – switches to SP from second interface input</p> <p>21 - switches to subsequent SP:  SP1&gt;&gt;SP2&gt;&gt;SP3&gt;&gt;SP4&gt;&gt;  SPIN1&gt;&gt;SPIN2&gt;&gt;SPIN3&gt;&gt;  SPMd1&gt;&gt; SPMd2&gt;&gt;SP1</p> <p>22 - switching to the second set of parameters for limiting the control signal</p>
7154	RW	0...22	<p>Function of binary input 3:</p> <p>0 – none</p> <p>1 – stop automatic control</p> <p>2 – switch to manual operation</p> <p>3 – switches to subsequent SP  SP1&lt;-&gt;SP2, SP2&lt;-&gt;SP3,  SP3&lt;-&gt;SP4, SP4&lt;-&gt;SP1</p> <p>4 – program start</p> <p>5 – jump to the next segment</p> <p>6 – stops the incrementing of the set value in program</p> <p>7 – end of the program</p> <p>8 – stop of the program with possible continuation</p> <p>9 – stop the program and jump to the beginning</p> <p>10 – switching to subsequent SP from the additional input - IN3</p> <p>11 – alarm reset of timer 1</p> <p>12 – alarm reset of timer 2</p> <p>13 – alarm reset of timer 3</p> <p>14 – alarm reset of timer 4</p> <p>15 – alarm reset of timer 5</p> <p>16 – alarm reset of timer 6</p> <p>17 – switching to SP from the input 1</p> <p>18 – switching to SP from the input 2</p> <p>19 – switches to SP from first interface input</p> <p>20 – switches to SP from second interface input</p> <p>21 - switches to subsequent SP:  SP1&gt;&gt;SP2&gt;&gt;SP3&gt;&gt;SP4&gt;&gt;  SPIN1&gt;&gt;SPIN2&gt;&gt;SPIN3&gt;&gt;  SPMd1&gt;&gt; SPMd2&gt;&gt;SP1</p> <p>22 - switching to the second set of parameters for limiting the control signal</p>

7156	RW	0...22	<p>Allocation of output 1:</p> <ul style="list-style-type: none"> <li>0 – none</li> <li>1 – loop 1</li> <li>2 – loop 2</li> <li>3 – input 1</li> <li>4 – input 2</li> <li>5 – input 3</li> <li>6 – input 1 + input 2 + input 3</li> <li>7 – binary input 1</li> <li>8 – binary input 2</li> <li>9 – binary input 3</li> <li>10 – inverted binary input 1</li> <li>11 – inverted binary input 2</li> <li>12 – inverted binary input 3</li> <li>13 – interface input 1</li> <li>14 – interface input 2</li> <li>15 – interface binary input 1 (register 4055)</li> <li>16 – interface binary input 2 (register 4056)</li> <li>17 – interface binary input 3 (register 4057)</li> <li>18 – inverted interface binary input 1 (register 4055)</li> <li>19 – inverted interface binary input 2 (register 4056)</li> <li>20 – inverted interface binary input 3 (register 4057)</li> <li>21 – control of output 1 through interface (register 4058)</li> <li>22 – inverted control of output 1 through interface (register 4058)</li> </ul>
7158	RW	0...7	<p>Output 1 function:</p> <ul style="list-style-type: none"> <li>0 – none</li> <li>1 – heating</li> <li>2 – cooling</li> <li>3 – opening a valve</li> <li>4 – closing a valve</li> <li>5 – alarm 1</li> <li>6 – programming control event</li> <li>7 – slave loop signal by cascade control</li> <li>8 – timer 1 alarm</li> </ul>

7160	RW	0...7	Output 1 program event: 0 – none 1 – event 1 from a segment 2 – event 2 from a segment 3 – event 3 from a segment 4 – event 4 from a segment 5 – event 5 from a segment 6 – event 6 from a segment 7 – deviation block
7162	RW	0.5...99.9	Output 1 imp. period
7164	RW	0...22	Allocation of output 2: 0 – none 1 – loop 1 2 – loop 2 3 – input 1 4 – input 2 5 – input 3 6 – input 1 + input 2 + input 3 7 – binary input 1 8 – binary input 2 9 – binary input 3 10 – inverted binary input 1 11 – inverted binary input 2 12 – inverted binary input 3 13 – interface input 1 14 – interface input 2 15 – interface binary input 1 (register 4055) 16 – interface binary input 2 (register 4056) 17 – interface binary input 3 (register 4057) 18 – inverted interface binary input 1 (register 4055) 19 – inverted interface binary input 2 (register 4056) 20 – inverted interface binary input 3 (register 4057) 21 – control of output 2 through interface (register 4059) 22 – inverted control of output 2 through interface (register 4059)

7166	RW	0...7	Output 2 function: 0 – none 1 – heating 2 – cooling 3 – opening a valve 4 – closing a valve 5 – alarm 2 6 – programming control event 7 – slave loop signal by cascade control 8 – timer 2 alarm
7168		0...7	Output 2 program event: 0 – none 1 – event 1 from a segment 2 – event 2 from a segment 3 – event 3 from a segment 4 – event 4 from a segment 5 – event 5 from a segment 6 – event 6 from a segment 7 – deviation block
7170	RW	0.5...99.9	Output 2 imp. period
7172	RW	0...22	Allocation of input 3: 0 – none 1 – loop 1 2 – loop 2 3 – input 1 4 – input 2 5 – input 3 6 – input 1 + input 2 + input 3 7 – binary input 1 8 – binary input 2 9 – binary input 3 10 – inverted binary input 1 11 – inverted binary input 2 12 – inverted binary input 3 13 – interface input 1 14 – interface input 2 15 – interface binary input 1 (register 4055) 16 – interface binary input 2 (register 4056) 17 – interface binary input 3 (register 4057) 18 – inverted interface binary input 1 (register 4055)

			<ul style="list-style-type: none"> <li>19 – inverted interface binary input 2 (register 4056)</li> <li>20 – inverted interface binary input 3 (register 4057)</li> <li>21 – control of output 2 through interface (register 4060)</li> <li>22 – inverted control of output 2 through interface (register 4060)</li> </ul>
7174	RW	0...7	<p>Output 3 function:</p> <ul style="list-style-type: none"> <li>0 – none</li> <li>1 – heating</li> <li>2 – cooling</li> <li>3 – opening a valve</li> <li>4 – closing a valve</li> <li>5 – alarm 3</li> <li>6 – programming control event</li> <li>7 – slave loop signal by cascade control</li> <li>8 – timer 3 alarm</li> </ul>
7176		0...7	<p>Output 3 program event:</p> <ul style="list-style-type: none"> <li>0 – none</li> <li>1 – event 1 from a segment</li> <li>2 – event 2 from a segment</li> <li>3 – event 3 from a segment</li> <li>4 – event 4 from a segment</li> <li>5 – event 5 from a segment</li> <li>6 – event 6 from a segment</li> <li>7 – deviation block</li> </ul>
7178	RW	0.5...99.9	Output 3 imp. period
7180	RW	0...22	<p>Allocation of input 4:</p> <ul style="list-style-type: none"> <li>0 – none</li> <li>1 – loop 1</li> <li>2 – loop 2</li> <li>3 – input 1</li> <li>4 – input 2</li> <li>5 – input 3</li> <li>6 – input 1 + input 2 + input 3</li> <li>7 – binary input 1</li> <li>8 – binary input 2</li> <li>9 – binary input 3</li> <li>10 – inverted binary input 1</li> <li>11 – inverted binary input 2</li> <li>12 – inverted binary input 3</li> </ul>

			<ul style="list-style-type: none"> <li>13 – interface input 1</li> <li>14 – interface input 2</li> <li>15 – interface binary input 1 (register 4055)</li> <li>16 – interface binary input 2 (register 4056)</li> <li>17 – interface binary input 3 (register 4057)</li> <li>18 – inverted interface binary input 1 (register 4055)</li> <li>19 – inverted interface binary input 2 (register 4056)</li> <li>20 – inverted interface binary input 3 (register 4057)</li> <li>21 – control of output 4 through interface (register 4061)</li> <li>22 – inverted control of output 4 through interface (register 4061)</li> </ul>
7182	RW	0...7	<p>Output 4 function:</p> <ul style="list-style-type: none"> <li>0 – none</li> <li>1 – heating</li> <li>2 – cooling</li> <li>3 – opening a valve</li> <li>4 – closing a valve</li> <li>5 – alarm 4</li> <li>6 – programming control event</li> <li>7 – slave loop signal by cascade control</li> <li>8 – timer 4 alarm</li> </ul>
7184		0...7	<p>Output 4 program event:</p> <ul style="list-style-type: none"> <li>0 – none</li> <li>1 – event 1 from a segment</li> <li>2 – event 2 from a segment</li> <li>3 – event 3 from a segment</li> <li>4 – event 4 from a segment</li> <li>5 – event 5 from a segment</li> <li>6 – event 6 from a segment</li> <li>7 – deviation block</li> </ul>
7186	RW	0.5...99.9	Output 4 imp. period

7188	RW	0...12	<p>Allocation of input 5:</p> <ul style="list-style-type: none"> <li>0 – none</li> <li>1 – loop 1</li> <li>2 – loop 2</li> <li>3 – input 1</li> <li>4 – input 2</li> <li>5 – input 3</li> <li>6 – input 1 + input 2 + input 3</li> <li>7 – binary input 1</li> <li>8 – binary input 2</li> <li>9 – binary input 3</li> <li>10 – inverted binary input 1</li> <li>11 – inverted binary input 2</li> <li>12 – inverted binary input 3</li> <li>13 – interface input 1</li> <li>14 – interface input 2</li> <li>15 – interface binary input 1 (register 4055)</li> <li>16 – interface binary input 2 (register 4056)</li> <li>17 – interface binary input 3 (register 4057)</li> <li>18 – inverted interface binary input 1 (register 4055)</li> <li>19 – inverted interface binary input 2 (register 4056)</li> <li>20 – inverted interface binary input 3 (register 4057)</li> <li>21 – control of output 5 through interface (register 4062)</li> <li>22 – inverted control of output 5 through interface (register 4062)</li> </ul>
7190	RW	0...7	<p>Output 5 function:</p> <ul style="list-style-type: none"> <li>0 – none</li> <li>1 – heating</li> <li>2 – cooling</li> <li>3 – opening a valve</li> <li>4 – closing a valve</li> <li>5 – alarm 5</li> <li>6 – programming control event</li> <li>7 – slave loop signal by cascade control</li> <li>8 – timer 5 alarm</li> </ul>



7192		0...7	Output 5 program event: 0 – none 1 – event 1 from a segment 2 – event 2 from a segment 3 – event 3 from a segment 4 – event 4 from a segment 5 – event 5 from a segment 6 – event 6 from a segment 7 – deviation block
7194	RW	0.5...99.9	Output 5 imp. period
7196	RW	0...22	Allocation of input 6: 0 – none 1 – loop 1 2 – loop 2 3 – input 1 4 – input 2 5 – input 3 6 – input 1 + input 2 + input 3 7 – binary input 1 8 – binary input 2 9 – binary input 3 10 – inverted binary input 1 11 – inverted binary input 2 12 – inverted binary input 3 13 – interface input 1 14 – interface input 2 15 – interface binary input 1 (register 4055) 16 – interface binary input 2 (register 4056) 17 – interface binary input 3 (register 4057) 18 – inverted interface binary input 1 (register 4055) 19 – inverted interface binary input 2 (register 4056) 20 – inverted interface binary input 3 (register 4057) 21 – control of output 6 through interface (register 4063) 22 – inverted control of output 6 through interface (register 4063)

7198		0...7	Output 6 function: 0 – none 1 – heating 2 – cooling 3 – opening a valve 4 – closing a valve 5 – alarm 6 6 – programming control event 7 – slave loop signal by cascade control 8 – timer 6 alarm
7200	RW	0...7	Output 6 program event: 0 – none 1 – event 1 from a segment 2 – event 2 from a segment
			3 – event 3 from a segment 4 – event 4 from a segment 5 – event 5 from a segment 6 – event 6 from a segment 7 – deviation block
7202	RW	0.5...99.9	Output 6 imp. period
7204	RW	0...8	Allocation of analog output 1: 0 – none 1 – loop 1 2 – loop 2 3 – input 1 4 – input 2 5 – input 3 6 – input 1 + input 2 + input 3 7 – interface input 1 8 – interface input 2
7206	RW	0...3	Linear output 1 function: 0 – none 1 – heating 2 – cooling 3 – retransmission
7208	RW	0...2	Analog output 1 retransmission source: 0 – measuring value 1 – set value 2 – set value – measuring value

7210	RW	-9999... 99999	Min for retr. of analog output 1
7212	RW	-9999... 99999	Max for retr. of analog output 1
7214	RW	0...2	I-output type for analog output 1: 0 – none 1 – 4...20 mA 2 – 0...20 mA
7216	RW	0...2	U-output type for analog output 1: 0 – none 1 – 0...5 V 2 – 0...10 V
7218	RW	0...8	Allocation of analog output 2: 0 – none 1 – loop 1 2 – loop 2 3 – input 1 4 – input 2 5 – input 3 6 – input 1 + input 2 + input 3 7 – interface input 1 8 – interface input 2
7220	RW	0...3	Linear output 2 function: 0 – none 1 – heating 2 – cooling 3 – retransmission
7222	RW	0...2	Analog output 2 retransmission source: 0 – measuring value 1 – set point value 2 – set point value – measuring value
7224	RW	-9999... 99999	Min for retr. of analog output 2
7226	RW	-9999... 99999	Max for retr. of analog output 2

7228	RW	0...2	I-output type for analog output 2: 0 – none 1 – 4...20 mA 2 – 0...20 mA
7230	RW	0...2	U-output type for analog output 2: 0 – none 1 – 0...5 V 2 – 0...10 V
7232	RW	0...7	Measuring value in loop 1: 0 – input 1 1 – input 2 2 – input 3 3 – input 1 + input 2 4 – input 1 + input 3 5 – input 2 + input 3 6 – interface input 1 7 – interface input 2
7234	RW	-10.0...10.0	Input 1 coefficient in loop 1
7236	RW	-10.0...10.0	Input 2 coefficient in loop 1
7238	RW	-10.0...10.0	Input 3 coefficient in loop 1
7240	RW	0...14	Binary inputs in loop 1: 0 – none 1 – binary input 1 2 – binary input 2 3 – binary input 3 4 – binary input 1 and 2 5 – binary input 1 and 3 6 – binary input 2 and 3 7 – binary input 1, 2 and 3 8 – interface binary input 1 9 – interface binary input 2 10 – interface binary input 3 11 – interface binary input 1 and 2 12 – interface binary input 1 and 3 13 – interface binary input 2 and 3 14 – interface binary input 1, 2 and 3

7242	RW	0...9	<p>SP type in loop 1:</p> <ul style="list-style-type: none"> <li>0 – SP1 set point value</li> <li>1 – SP2 set point value</li> <li>2 – SP3 set point value</li> <li>3 – SP4 set point value</li> <li>4 – set point value from input 3</li> <li>5 – set point value from program</li> <li>6 – set point value from input 1</li> <li>7 – set point value from input 2</li> <li>8 – setpoint value from interface input 1</li> <li>9 – setpoint value from interface input 2</li> </ul>
7244	RW	0...29	<p>Program number on loop 1:</p> <ul style="list-style-type: none"> <li>0 – program number 1</li> <li>1 – program number 2</li> <li>2 – program number 3</li> <li>3 – program number 4</li> <li>4 – program number 5</li> <li>5 – program number 6</li> <li>6 – program number 7</li> <li>7 – program number 8</li> <li>8 – program number 9</li> <li>9 – program number 10</li> <li>10 – program number 11</li> <li>11 – program number 12</li> <li>12 – program number 13</li> <li>13 – program number 14</li> <li>14 – program number 15</li> <li>15 – program number 16</li> <li>16 – program number 17</li> <li>17 – program number 18</li> <li>18 – program number 19</li> <li>19 – program number 20</li> <li>20 – program number 21</li> <li>21 – program number 22</li> <li>22 – program number 23</li> <li>23 – program number 24</li> <li>24 – program number 25</li> <li>25 – program number 26</li> <li>26 – program number 27</li> <li>27 – program number 28</li> <li>28 – program number 29</li> <li>29 – program number 30</li> </ul>
7246	RW	-9999...99999	SP1 set value in loop 1

7248	RW	-9999...99999	SP2 set value in loop 1
7250	RW	-9999...99999	SP3 set value in loop 1
7252	RW	-9999...99999	SP4 set value in loop 1
7254	RW	-9999...99999	SP setting lower limit in loop 1
7256	RW	-9999...99999	SP setting upper limit in loop 1
7258	RW	0...2	Set value accrual in loop 1: 0 – off 1 – accrual in units / minute 2 – accrual in units / hour
7260	RW	-9999...99999	Set value Ramp rate in loop 1
7262	RW	0...5	Control type in loop 1: 0 – control off 1 – heating-type control 2 – cooling-type control 3 – heating-cooling control 4 – step-by-step valve control 5 – step-by-step feedback valve control
7264	RW	0...1	Control algorithm in loop 1: 0 – on-off algorithm 1 – PID algorithm
7266	RW	0,1...100,0	Hysteresis in loop 1
7268	RW	-99.9...99.9	Distance range in loop 1
7270	RW	-100.0...100.0	Control signal in loop 1
7272	RW	-9999...99999	Control lower limit in loop 1
7274	RW	-9999...99999	Control upper limit in loop 1
7276	RW	0...550.0 [°C] 0...990.0 [°F]	PID1 set proportional band in loop 1
7278	RW	0...9999	Integration time constant [s] from PID1 set in the loop 1
7280	RW	0.0...2500.0	Differentiation time constant [s] from PID1 set in the loop 1

7282	RW	0.0...100.0	Control signal correction for P or PD of PID1 set in loop 1
7284	RW	0...550.0 [°C] 0...990.0 [°F]	PID2 set proportional band in loop 1
7286	RW	0...9999	Integration time constant [s] from PID2 set in the loop 1
7288	RW	0.0...2500.0	Differentiation time constant [s] from PID2 set in the loop 1
7290	RW	0.0...100.0	Control signal correction for P or PD of PID2 set in loop 1
7292	RW	0...550.0 [°C] 0...990.0 [°F]	PID3 set proportional band in loop 1
7294	RW	0...9999	Integration time constant [s] from PID3 set in the loop 1
7296	RW	0.0...2500.0	Differentiation time constant [s] from PID3 set in the loop 1
7298	RW	0.0...100.0	Control signal correction for P or PD of PID3 set in loop 1
7300	RW	0...550.0 [°C] 0...990.0 [°F]	PID4 set proportional band in loop 1
7302	RW	0...9999	Integration time constant [s] from PID4 set in the loop 1
7304	RW	0.0...2500.0	Differentiation time constant [s] from PID4 set in the loop 1
7306	RW	0.0...100.0	Control signal correction for P or PD of PID4 set in loop 1
7308	RW	0.1...200.0 [%]	Proportional band of cooling loop in loop 1
7310	RW	0...9999	Integration time constant [s] of cooling loop in the loop 1
7312	RW	0.0...2500.0	Differentiation time constant [s] of cooling loop in the loop 1

7314	RW	0...2	„Gain Scheduling” function in loop 1: 0 – off 1 – switched according to set value 2 – selected fixed PID set
7316	RW	0...2	Number of PID sets for Gain Scheduling, switched according to the value set in loop 1: 0 – 2 PID sets used 1 – 3 PID sets used 2 – 4 PID sets used
7318	RW	-9999...99999	Switching level for PID1 and PID2 set, switched as per value set in loop 1
7320	RW	-9999...99999	Switching level for PID2 and PID3 set, switched as per value set in loop 1
7322	RW	-9999...99999	Switching level for PID3 and PID4 set, switched as per value set in loop 1
7324	RW	0...3	Fixed PID set for Gain Scheduling in loop 1: 0 – PID1 set 1 – PID2 set 2 – PID3 set 3 – PID4 set
7326	RW	0...7	Measuring value in loop 2: 0 – input 1 1 – input 2 2 – input 3 3 – input 1 + input 2 4 – input 1 + input 3 5 – input 2 + input 3 6 – interface input 1 7 – interface input 2
7328	RW	-10.0...10.0	Input 1 coefficient in loop 2
7330	RW	-10.0...10.0	Input 2 coefficient in loop 2
7332	RW	-10.0...10.0	Input 3 coefficient in loop 2



7334	RW	0...14	<p>Binary inputs in loop 2:</p> <ul style="list-style-type: none"> <li>0 – none</li> <li>1 – binary input 1</li> <li>2 – binary input 2</li> <li>3 – binary input 3</li> <li>4 – binary input 1 and 2</li> <li>5 – binary input 1 and 3</li> <li>6 – binary input 2 and 3</li> <li>7 – binary input 1, 2 and 3</li> <li>8 – interface binary input 1</li> <li>9 – interface binary input 2</li> <li>10 – interface binary input 3</li> <li>11 – interface binary input 1 and 2</li> <li>12 – interface binary input 1 and 3</li> <li>13 – interface binary input 2 and 3</li> <li>14 – interface binary input 1, 2 and 3</li> </ul>
7336	RW	0...9	<p>SP type in loop 2:</p> <ul style="list-style-type: none"> <li>0 – SP1 set point value</li> <li>1 – SP2 set point value</li> <li>2 – SP3 set point value</li> <li>3 – SP4 set point value</li> <li>4 – set point value from input 3</li> <li>5 – set point value from program</li> <li>6 – set point value from input 1</li> <li>7 – set point value from input 2</li> <li>8 – setpoint value from interface input 1</li> <li>9 – setpoint value from interface input 2</li> </ul>
7338	RW	30...59	<p>Program number on loop 2:</p> <ul style="list-style-type: none"> <li>30 – program number 31</li> <li>31 – program number 32</li> <li>32 – program number 33</li> <li>33 – program number 34</li> <li>34 – program number 35</li> <li>35 – program number 36</li> <li>36 – program number 37</li> <li>37 – program number 38</li> <li>38 – program number 39</li> <li>39 – program number 40</li> <li>40 – program number 41</li> <li>41 – program number 42</li> <li>42 – program number 43</li> <li>43 – program number 44</li> <li>44 – program number 45</li> </ul>

			45 – program number 46 46 – program number 47 47 – program number 48 48 – program number 49 49 – program number 50 50 – program number 51 51 – program number 52 52 – program number 53 53 – program number 54 54 – program number 55 55 – program number 56 56 – program number 57 57 – program number 58 58 – program number 59 59 – program number 60
7340	RW	-9999...99999	SP1 set value in loop 2
7342	RW	-9999...99999	SP2 set value in loop 2
7344	RW	-9999...99999	SP3 set value in loop 2
7346	RW	-9999...99999	SP4 set value in loop 2
7348	RW	-9999...99999	SP setting lower limit in loop 2
7350	RW	-9999...99999	SP setting upper limit in loop 2
7352	RW	0...2	Set value accrual in loop 2: 0 – off 1 – accrual in units / minute 2 – accrual in units / hour
7354	RW	-9999...99999	Set value Ramp rate in loop 2
7356	RW	0...5	Control type in loop 2: 0 – control off 1 – heating-type control 2 – cooling-type control 3 – heating-cooling control 4 – step-by-step valve control 5 – step-by-step feedback valve control 6 – cascade control
7358	RW	0...1	Control algorithm in loop 2: 0 – on-off algorithm 1 – PID algorithm

7360	RW	0.1...100.0	Hysteresis in loop 2
7362	RW	-99.9...99.9	Distance range in loop 2
7364	RW	-100.0...100.0	Control signal in loop 2
7366	RW	-9999...99999	Control lower limit in loop 2
7368	RW	-9999...99999	Control upper limit in loop 2
7370	RW	0...550.0 [°C] 0...990.0 [°F]	PID1 set proportional band in loop 2
7372	RW	0...9999	Integration time constant [s] from PID1 set in the loop 2
7374	RW	0.0...2500.0	Differentiation time constant [s] from PID1 set in the loop 2
7376	RW	0.0...100.0	Control signal correction for P or PD of PID1 set in loop 2
7378	RW	0...550.0 [°C] 0...990.0 [°F]	PID2 set proportional band in loop 2
7380	RW	0...9999	Integration time constant [s] from PID2 set in the loop 2
7382	RW	0.0...2500.0	Differentiation time constant [s] from PID2 set in the loop 2
7384	RW	0.0...100.0	Control signal correction for P or PD of PID2 set in loop 2
7386	RW	0...550.0 [°C] 0...990.0 [°F]	PID3 set proportional band in loop 2
7388	RW	0...9999	Integration time constant [s] from PID3 set in the loop 2
7390	RW	0.0...2500.0	Differentiation time constant [s] from PID3 set in the loop 2
7392	RW	0.0...100.0	Control signal correction for P or PD of PID3 set in loop 2
7394	RW	0...550.0 [°C] 0...990.0 [°F]	PID4 set proportional band in loop 2

7396	RW	0...9999	Integration time constant [s] from PID4 set in the loop 2
7398	RW	0.0...2500.0	Differentiation time constant [s] from PID4 set in the loop 2
7400	RW	0.0...100.0	Control signal correction for P or PD of PID4 set in loop 2
7402	RW	0.1...200.0 [%]	Proportional band of cooling loop in loop 2
7404	RW	0...9999	Integration time constant [s] of cooling loop in the loop 2
7406	RW	0.0...2500.0	Differentiation time constant [s] of cooling loop in the loop 2
7408	RW	0...2	Gain Scheduling function in loop 2: 0 – off 1 – switched according to set value 2 – selected fixed PID set
7410	RW	0...2	Number of PID sets for Gain Scheduling, switched according to the value set in loop 2: 0 – 2 PID sets used 1 – 3 PID sets used 2 – 4 PID sets used
7412	RW	-9999...99999	Switching level for PID1 and PID2 set, switched as per value set in loop 2
7414	RW	-9999...99999	Switching level for PID2 and PID3 set, switched as per value set in loop 2
7416	RW	-9999...99999	Switching level for PID3 and PID4 set, switched as per value set in loop 2
7418	RW	0...3	Fixed PID set for Gain Scheduling in loop 2: 0 – PID1 set 1 – PID2 set 2 – PID3 set 3 – PID4 set

7420	RW	0...5	Alarm type 1: 0 – absolute upper 1 – absolute lower 2 – relative upper 3 – relative lower 4 – relative internal 5 – relative internal
7422	RW	-9999...99999	Alarm 1 set value
7424	RW	-9999...99999	Alarm 1 deviation (for relative alarms)
7426	RW	0.1...99.9	Alarm 1 hysteresis
7428	RW	0...1	Memory of the alarm 1: 0 – off 1 – on
7430	RW	0...5	Alarm type 2: 0 – absolute upper 1 – absolute lower 2 – relative upper 3 – relative lower 4 – relative internal 5 – relative internal
7432	RW	-9999...99999	Alarm 2 set point value
7434	RW	-9999...99999	Alarm 2 deviation (for relative alarms)
7436	RW	0.1...99.9	Alarm 2 hysteresis
7438	RW	0...1	Memory of the alarm 2: 0 – off 1 – on
7440	RW	0...5	Alarm type 3: 0 – absolute upper 1 – absolute lower 2 – relative upper 3 – relative lower 4 – relative internal 5 – relative internal
7442	RW	-9999...99999	Alarm 3 set point value

7444	RW	-9999...99999	Alarm 3 deviation (for relative alarms)
7446	RW	0.1...99.9	Alarm 3 hysteresis
7448	RW	0...1	Memory of the alarm 3: 0 – off 1 – on
7450	RW	0...5	Alarm type 4: 0 – absolute upper 1 – absolute lower 2 – relative upper 3 – relative lower 4 – relative internal 5 – relative internal
7452	RW	-9999...99999	Alarm 4 set point value
7454	RW	-9999...99999	Alarm 4 deviation (for relative alarms)
7456	RW	0.1...99.9	Alarm 4 hysteresis
7458	RW	0...1	Memory of the alarm 4: 0 – off 1 – on
7460	RW	0...5	Alarm type 5: 0 – absolute upper 1 – absolute lower 2 – relative upper 3 – relative lower 4 – relative internal 5 – relative internal
7462	RW	-9999...99999	Alarm 5 set point value
7464	RW	-9999...99999	Alarm 5 deviation (for relative alarms)
7466	RW	0.1...99.9	Alarm 5 hysteresis
7468	RW	0...1	Memory of the alarm 5: 0 – off 1 – on

7470	RW	0...5	Alarm type 6: 0 – absolute upper 1 – absolute lower 2 – relative upper 3 – relative lower 4 – relative internal 5 – relative internal
7472	RW	-9999...99999	Alarm 6 set point value
7474	RW	-9999...99999	Alarm 6 deviation (for relative alarms)
7476	RW	0.1...99.9	Alarm 6 hysteresis
7478	RW	0...1	Memory of the alarm 6: 0 – off 1 – on
7480	RW	1...247	Address
7482	RW	0...5	Baud rate 0 – 4800 bps 1 – 9600 bps 2 – 19.2k bps 3 – 38.4k bps 4 – 57.6k bps 5 – 115.2k bps
7484	RW	0...4	Transmission protocol: 0 – none 1 – RTU 8N2 2 – RTU 8E1 3 – RTU 8O1 4 – RTU 8N1
7486	RW	0...10	LCD illumination
7488	RW	0...1	Language 0 – English 1 – Polish
7490	RW	0...1	Shot outputs state 0 – no 1 – yes
7492	RW	0...1	Show binary inputs state 0 – no 1 – yes

7494	RW	0...1	Show clock 0 – no 1 – yes
7496	RW	0.0...100.0 [%]	Minimum control signal in loop 1
7498	RW	0.0...100.0 [%]	Maximum control signal in loop 1
7500	RW	0.0...100.0 [%]	Minimum control signal in loop 2
7502	RW	0.0...100.0 [%]	Maximum control signal in loop 2
7504	RW	-9999...99999	Cascade control set point Lo
7506	RW	-9999...99999	Cascade control set point Hi
7508	RW	1..86400 [s]	Countdown time of alarm timer 1
7510	RW	1..86400 [s]	Countdown time of alarm timer 2
7512	RW	1..86400 [s]	Countdown time of alarm timer 3
7514	RW	1..86400 [s]	Countdown time of alarm timer 4
7516	RW	1..86400 [s]	Countdown time of alarm timer 5
7518	RW	1..86400 [s]	Countdown time of alarm timer 6
7520	RW	1..86400 [s]	Countdown time of alarm timer 1 latch
7522	RW	1..86400 [s]	Countdown time of alarm timer 2 latch
7524	RW	1..86400 [s]	Countdown time of alarm timer 3 latch
7526	RW	1..86400 [s]	Countdown time of alarm timer 4 latch
7528	RW	1..86400 [s]	Countdown time of alarm timer 5 latch
7530	RW	1..86400 [s]	Countdown time of alarm timer 6 latch
7532	RW	-9999...99999	Set point value for alarm timer 1
7534	RW	-9999...99999	Set point value for alarm timer 2
7536	RW	-9999...99999	Set point value for alarm timer 3



7538	RW	-9999...99999	Set point value for alarm timer 4
7540	RW	-9999...99999	Set point value for alarm timer 5
7542	RW	-9999...99999	Set point value for alarm timer 6
7544	RW	0...1	Alarm 1 status if the measuring range is exceeded: 0- disabled 1- enabled
7546	RW	0...1	Alarm 2 status if the measuring range is exceeded: 0- disabled 1- enabled
7548	RW	0...1	Alarm 3 status if the measuring range is exceeded: 0- disabled 1- enabled
7550	RW	0...1	Alarm 4 status if the measuring range is exceeded: 0- disabled 1- enabled
7552	RW	0...1	Alarm 5 status if the measuring range is exceeded: 0- disabled 1- enabled
7554	RW	0...1	Alarm 6 status if the measuring range is exceeded: 0- disabled 1- enabled
7556	RW	0...3600	Turning the backlight off after the entered time (in sec.) has passed. Enterin 0 disables the function.
7558	RW	0...1	Show achiving status: 0 – no 1 – yes
7560	RW	5...86400	Archiving interval for group 1 archiving
7562	RW	5...86400	Archiving interval for group 2 archiving
7564	RW	5...86400	Archiving interval for group 3 archiving

7566	RW	0... 0x00001FFF	The list of parameters selected for archiving in the archiving group 1: 0x00000001 - PV_Input1: measuring value at input 1 0x00000002 - PV_Input2: measuring value at input 2 0x00000004 - PV_Input3: measuring value at input 3 0x00000008 - PV_Loop 1: measuring value in loop 1 0x00000010 - SP_Loop 1: set point in loop 1 0x00000020 - CTRL1_Loop 1: control loop 1 control signal from loop 1 0x00000040 - CTRL2_Loop 1: control loop 2 control signal from loop 1 0x00000080 - PV_Loop2: measuring value in loop 2 0x00000100 - SP_Loop 2: set point in loop 2 0x00000200 - CTRL1_Loop 2: control loop 1 control signal from loop 2 0x00000400 - CTRL2_Loop 2: control loop 2 control signal from loop 2 0x00000800 - Modbus In1: value from interface input 1 0x00001000 - Modbus In2: value from interface input 2
7568	RW	0... 0x00001FFF	The list of parameters selected for archiving in the archiving group 2 as for 7566
7570	RW	0... 0x00001FFF	The list of parameters selected for archiving in the archiving group 3 as for 7566
7572	RW	-9999...99999	Set point for archiving group 1 at archiving type: AbsHigh, AbsLo
7574	RW	-9999...99999	Set point for archiving group 2 at archiving type: AbsHigh, AbsLo
7576 170	RW	-9999...99999	Set point for archiving group 3 at archiving type: AbsHigh, AbsLo

7578	RW	-9999...99999	Deviation for archiving group 1 at relative archiving type
7580	RW	-9999...99999	Deviation for archiving group 2 at relative archiving type
7582	RW	-9999...99999	Deviation for archiving group 3 at relative archiving type
7584	RW	0,1...99999	Hysteresis for archiving group 1 at relative and absolute archiving type
7586	RW	0,1...99999	Hysteresis for archiving group 2 at relative and absolute archiving type
7588	RW	0,1...99999	Hysteresis for archiving group 3 at relative and absolute archiving type
7590	RW	0...22	Function of interface binary input 1: 0 – none 1 – stop automatic control 2 – switch to manual operation 3 – switches to subsequent SP SP1<->SP2, SP2<->SP3, SP3<->SP4, SP4<->SP1 4 – program start 5 – jump to the next segment 6 – stops the incrementing of the set value in program 7 – end of the program 8 – stop of the program with possible continuation 9 – stop the program and jump to the beginning 10 – switching to SP from the additional input – WE3 11 – alarm reset of timer 1 12 – alarm reset of timer 2 13 – alarm reset of timer 3 14 – alarm reset of timer 4 15 – alarm reset of timer 5 16 – alarm reset of timer 6 17 – switching to SP from the input 1 18 – switching to SP from the input 2 19 – switching to SP from the first interface input 20 – switching to SP from the second interface input

			<p>21 - switching to subsequent SP: SP1&gt;&gt;SP2&gt;&gt;SP3&gt;&gt;SP4&gt;&gt;SPIN1&gt;&gt;SPIN2&gt;&gt;SPIN3&gt;&gt;SPMd1&gt;&gt;SPMd2&gt;&gt;SP1</p> <p>22 - switching to the second set of parameters for limiting the control signal</p>
7592	RW	0...22	<p>Function of interface binary input 2:</p> <p>0 – none</p> <p>1 – stop automatic control</p> <p>2 – switch to manual operation</p> <p>3 – switches to subsequent SP SP1&lt;-&gt;SP2, SP2&lt;-&gt;SP3, SP3&lt;-&gt;SP4, SP4&lt;-&gt;SP1</p> <p>4 – program start</p> <p>5 – jump to the next segment</p> <p>6 – stops the incrementing of the set value in program</p> <p>7 – end of the program</p> <p>8 – stop of the program with possible continuation</p> <p>9 – stop the program and jump to the beginning</p> <p>10 – switching to SP from the additional input – WE3</p> <p>11 – alarm reset of timer 1</p> <p>12 – alarm reset of timer 2</p> <p>13 – alarm reset of timer 3</p> <p>14 – alarm reset of timer 4</p> <p>15 – alarm reset of timer 5</p> <p>16 – alarm reset of timer 6</p> <p>17 – switching to SP from the input 1</p> <p>18 – switching to SP from the input 2</p> <p>19 – switching to SP from the first interface input</p> <p>20 – switching to SP from the second interface input</p> <p>21 - switching to subsequent SP: SP1&gt;&gt;SP2&gt;&gt;SP3&gt;&gt;SP4&gt;&gt;SPIN1&gt;&gt;SPIN2&gt;&gt;SPIN3&gt;&gt;SPMd1&gt;&gt;SPMd2&gt;&gt;SP1</p> <p>22 - switching to the second set of parameters for limiting the control signal</p>

7594	RW	0...22	<p>Function of interface binary input 3:</p> <ul style="list-style-type: none"> <li>0 – none</li> <li>1 – stop automatic control</li> <li>2 – switch to manual operation</li> <li>3 – switches to subsequent SP SP1&lt;-&gt;SP2, SP2&lt;-&gt;SP3, SP3&lt;-&gt;SP4, SP4&lt;-&gt;SP1</li> <li>4 – program start</li> <li>5 – jump to the next segment</li> <li>6 – stops the incrementing of the set value in program</li> <li>7 – end of the program</li> <li>8 – stop of the program with possible continuation</li> <li>9 – stop the program and jump to the beginning</li> <li>10 – switching to SP from the additional input – WE3</li> <li>11 – alarm reset of timer 1</li> <li>12 – alarm reset of timer 2</li> <li>13 – alarm reset of timer 3</li> <li>14 – alarm reset of timer 4</li> <li>15 – alarm reset of timer 5</li> <li>16 – alarm reset of timer 6</li> <li>17 – switching to SP from the input 1</li> <li>18 – switching to SP from the input 2</li> <li>19 – switching to SP from the first interface input</li> <li>20 – switching to SP from the second interface input</li> <li>21 - switching to subsequent SP: SP1&gt;&gt;SP2&gt;&gt;SP3&gt;&gt;SP4&gt;&gt;SPIN1&gt;&gt;SPIN2&gt;&gt;SPIN3&gt;&gt;SPMd1&gt;&gt; SPMd2&gt;&gt;SP1</li> <li>22 - switching to the second set of parameters for limiting the control signal</li> </ul>
------	----	--------	---

7596	RW	0x0000... ...0x1FFF	<p>List of the displayed controller screens selection</p> <p>0x0001 - show the „Channel 1” screen,  0x0002 - show the „Channel 2” screen,  0x0004 - show the „Channel 1/2” screen,  0x0008 - show the screen „1 screen of values”,  0x0010 - show the screen „2 screen of values”,  0x0020 - show the screen „3 screen of values”,  0x0040 - show the „Timers” screen,  0x0080 - show the „Timer 1” screen,  0x0100 - show the „Timer 2” screen,  0x0200 - show the „Timer 3” screen,  0x0400 - show the „Timer 4” screen,  0x0800 - show the „Timer 5” screen,  0x1000 - show the „Timer 6” screen,</p>
7598	RW	0...3600 s	<p>Time of automatic switching between successive screens</p> <p>0 - automatic switching off,  1 ... 3600 - time in seconds between successive screens switching</p>

Register address	Marking	Operations	Parameter range	Description
7600		RW	0...29	Number of realized program (30 means thirty-first program) – loop 2
7602		RW	0...1	Program start/stop – loop 1 0 – program stop 1 – program start (saving causes program to start from the beginning)
7604		RW	0...1	Program set value accrual stop – loop 1 0 – off 1 – on
7606		RW	0...14	Realized segment (0 means first segment) – loop 1 Saving causes a jump to the given segment
7608		R-		Control status – loop 1 0 – control stop (in the first section) 1 – control stop (in the current section) 2 – program running 3 – control deviation block active 4 – set value accrual stop (via button, binary input or interface) 5 – program end
7610		R-		Number of cycles left - loop 1
7612		R-		Section time elapsed [s] - loop 1
7614		R-		Segment time remaining [s] – loop 1

7616		R-		Program time elapsed [s] - loop 1
7618		R-		Program time remaining [s] – loop 1
7620		RW		Reserved
7622		RW		Reserved
7624		RW		Reserved
7626		RW		Reserved
7628		RW		Reserved
7630		RW	30...59	Number of realized program (30 means program) – loop 2
7632		RW	0...1	Program start/stop – loop 2 0 – program stop 1 – program start (saving causes program to start from the beginning)
7634		RW	0...1	Program set value accrual stop – loop 2 0 – off 1 – on
7636		RW	0...14	Realized segment (0 means first segment) – loop 2 Saving causes a jump to the given segment
7638		R-		Control status – loop 2 0 – control stop (in the first section) 1 – control stop (in the current section) 2 – program running 3 – control deviation block active 4 – set value accrual stop (via button, binary input or interface) 5 – program end
7640		R-		Number of cycles left - loop 2



7642		R-		Section time elapsed [s] - loop 2
7644		R-		Segment time remaining [s] – loop 2
7646		R-		Program time elapsed [s] - loop 2
7648		R-		Program time remaining [s] – loop 2
7650		RW		Reserved
7652		RW		Reserved
7654		RW		Reserved
7656		RW		Reserved
7658		RW		Reserved

<b>Address first register</b>	<b>Last register address</b>	<b>Description</b>
7660	7676	Program 1 parameters
7678	7886	Sections 1 – 15 of program 1
7888	7904	Program 2 parameters
7906	8114	Sections 1 – 15 of program 2
8116	8132	Program 3 parameters
8134	8342	Sections 1 – 15 of program 3
8344	8360	Program 4 parameters
8362	8570	Sections 1 – 15 of program 4
8572	8588	Program 5 parameters
8590	8798	Sections 1 – 15 of program 5
8800	8816	Program 6 parameters
8818	9028	Sections 1 – 15 of program 6
9028	9044	Program 7 parameters
9046	9254	Sections 1 – 15 of program 7
9256	9272	Program 8 parameters
9274	9482	Sections 1 – 15 of program 8
9484	9500	Program 9 parameters
9502	9710	Sections 1 – 15 of program 9
9712	9728	Program 10 parameters
9730	9938	Sections 1 – 15 of program 10
9940	9956	Program 11 parameters

9958	10166	Sections 1 – 15 of program 11
10168	10184	Program 12 parameters
10186	10394	Sections 1 – 15 of program 12
10396	10412	Program 13 parameters
10414	10622	Sections 1 – 15 of program 13
10624	10640	Program 14 parameters
10642	10850	Sections 1 – 15 of program 14
10852	10868	Program 15 parameters
10870	11078	Sections 1 – 15 of program 15
11080	11096	Program 16 parameters
11098	11306	Sections 1 – 15 of program 16
11308	11324	Program 17 parameters
11326	11534	Sections 1 – 15 of program 17
11536	11552	Program 18 parameters
11554	11762	Sections 1 – 15 of program 18
11764	11780	Program 19 parameters
11782	11990	Sections 1 – 15 of program 19
11992	12008	Program 20 parameters
12010	12218	Sections 1 – 15 of program 20
12220	12236	Program 21 parameters
12238	12446	Sections 1-15 of program 21
12448	12464	Program 22 parameters
12466	12674	Sections 1-15 of program 22
12676	12692	Program 23 parameters
12694	12902	Sections 1-15 of program 23

12904	12920	Program 24 parameters
12922	13130	Sections 1-15 of program 24
13132	13148	Program 25 parameters
13150	13358	Sections 1-15 of program 25
13360	13376	Program 26 parameters
13378	13568	Sections 1-15 of program 26
13588	13604	Program 27 parameters
13606	13814	Sections 1-15 of program 27
13816	13832	Program 28 parameters
13834	14042	Sections 1-15 of program 28
14044	14060	Program 29 parameters
14062	14270	Sections 1-15 of program 29
14272	14228	Program 30 parameters 0
14290	14498	Sections 1-15 of program 30
14500	14516	Program 31 parameters
14518	14726	Sections 1-15 of program 31
14728	14744	Program 32 parameters
14746	14954	Sections 1-15 of program 32
14956	14972	Program 33 parameters
14974	15182	Sections 1-15 of program 33
15184	15200	Program 34 parameters
15202	15410	Sections 1-15 of program 34
15412	15428	Program 35 parameters
15430	15638	Sections 1-15 of program 35
15640	15656	Program 36 parameters

15658	15866	Sections 1-15 of program 36
15868	15884	Program 37 parameters
15886	16094	Sections 1-15 of program 37
16096	16112	Program 38 parameters
16114	16322	Sections 1-15 of program 38
16324	16340	Program 39 parameters
16342	16550	Sections 1-15 of program 39
16552	16568	Program 40 parameters
16570	16778	Sections 1-15 of program 40
16780	16796	Program 41 parameters
16798	17006	Sections 1-15 of program 41
17008	17024	Program 42 parameters
17026	17234	Sections 1-15 of program 42
17236	17252	Program 43 parameters
17254	17462	Sections 1-15 of program 43
17464	17480	Program 44 parameters
17482	17690	Sections 1-15 of program 44
17692	17708	Program 45 parameters
17710	17918	Sections 1-15 of program 45
17920	17936	Program 46 parameters
17938	18146	Sections 1-15 of program 46
18148	18164	Program 47 parameters
18166	18374	Sections 1-15 of program 47
18376	18392	Program 48 parameters
18394	18602	Sections 1-15 of program 48

18604	18620	Program 49 parameters
18622	18830	Sections 1-15 of program 49
18832	18848	Program 50 parameters
18850	19058	Sections 1-15 of program 50
19060	19076	Program 51 parameters
19078	19286	Sections 1-15 of program 51
19288	19304	Program 52 parameters
19306	19514	Sections 1-15 of program 52
19516	19532	Program 53 parameters
19534	19742	Sections 1-15 of program 53
19744	19760	Program 54 parameters
19762	19970	Sections 1-15 of program 54
19972	19988	Program 55 parameters
19990	20198	Sections 1-15 of program 55
20200	20216	Program 56 parameters
20218	20426	Sections 1-15 of program 56
20428	20444	Program 57 parameters
20446	20654	Sections 1-15 of program 57
20656	20672	Program 58 parameters
20674	20882	Sections 1-15 of program 58
20884	20900	Program 59 parameters
20902	21110	Sections 1-15 of program 59
21112	21128	Program 60 parameters
21130	21338	Sections 1-15 of program 60

Register address		Marking	Operations	Parameter range	Description
+ 0	Program parameters	PrgStart	RW	0...1	Program start method 0 – from the value defined by SP0 1 – from the current measured value
+ 2		Start SP	RW	MIN..MAX 1)	Initial set point value
+ 4		Time Unit	RW	0...1	Unit of the segment duration time 0 – minutes and seconds 1 – hours and minutes
+ 6		Ramp Unit	RW	0...1	Unit of the set value Ramp rate 0 – minutes 1 – hours
+ 8		Holdback Type	RW	0...3	Control deviation block 0 – inactive 1 – lower 2 – upper 3 – double-sided
+ 10		Cycles Number	RW	1...999	Program iteration no.

+ 12		Power Fail	RW	0...1	Control after supply decay 0 – program continuation 1 – control stop
+ 14		End Type	RW	0...1	Program end control 0 – control stop 1 – fixed set-point control with set value from last segment
+ 16		Gain Sched.	RW	0...1	„Gain Scheduling” function for program 0 – off 1 – on
+ 0	Segment 1	Seg.Type	RW	0...3	Segment type 0 – time-defined segment 1 – accrual-defined segment 2 – set value hold 3 – program end
+ 2		Target SP	RW	MIN..MAX 1)	Set value at the end of a segment
+ 4		Seg. Duration	RW	1...5999	Segment duration time
+ 6		Ramp Rate	RW	1...5500 1)	Set value Ramp rate
+ 8		Holdback Val	RW	0...2000 1)	Upper control deviation value; when it is exceeded, set value accrual is stopped



+ 10		Events	RW	0...7	Events state (bit sum) bit 0 set – event 1 bit 1 set – event 2 bit 2 set – event 3 bit 3 set – event 4 bit 4 set – event 5 bit 5 set – event 6
+ 12		PID	RW	0...3	PID set for a segment 0 – PID1 1 – PID2 2 – PID3 3 – PID4
+ 14	Segment 2	Seg.Type	as per segment 1		
+ 16		Target SP			
+ 18		Segment time			
+ 20		Ramp rate			
+ 22		Holdback Val			
+ 24		Events			
+ 26		PID			
+ 28	Segment 3	Seg.Type	as per segment 1		
+ 30		Target SP			
+ 32		Segment time			
+ 34		Ramp rate			
+ 36		Holdback Val			
+ 38		Events			
+ 40		PID			

+ 42	Segment 4	Seg.Type	as per segment 1
+ 44		Target SP	
+ 46		Segment time	
+ 48		Ramp rate	
+ 50		Holdback Val	
+ 52		Events	
+ 54		PID	
+ 56	Segment 5	Seg.Type	as per segment 1
+ 58		Target SP	
+ 60		Segment time	
+ 62		Ramp rate	
+ 64		Holdback Val	
+ 66		Events	
+ 68		PID	

+ 70	Segment 6	Seg.Type	as per segment 1
+ 72		Target SP	
+ 74		Segment time	
+ 76		Ramp rate	
+ 78		Holdback Val	
+ 80		Events	
+ 82		PID	
+ 84	Segment 7	Seg.Type	as per segment 1
+ 86		Target SP	
+ 88		Segment time	
+ 90		Ramp rate	
+ 92		Holdback Val	
+ 94		Events	
+ 96		PID	

+ 98	Segment 8	Seg. Type	as per segment 1
+ 100		Target SP	
+ 102		Segment time	
+ 104		Ramp rate	
+ 106		Holdback Val	
+ 108		Events	
+ 110		PID	
+ 112	Segment 9	Seg. Type	as per segment 1
+ 114		Target SP	
+ 116		Segment time	
+ 118		Ramp rate	
+ 120		Holdback Val	
+ 122		Events	
+ 124		PID	
+ 126	Segment 10	Seg. Type	as per segment 1
+ 128		Target SP	
+ 130		Segment time	
+ 132		Ramp rate	
+ 134		Holdback Val	
+ 136		Events	
+ 138		PID	

+ 140	Segment 11	Seg.Type	as per segment 1
+ 142		Target SP	
+ 144		Segment time	
+ 146		Ramp rate	
+ 148		Holdback Val	
+ 150		Events	
+ 152		PID	
+ 154	Segment 12	Seg.Type	as per segment 1
+ 156		Target SP	
+ 158		Segment time	
+ 160		Ramp rate	
+ 162		Holdback Val	
+ 164		Events	
+ 166		PID	
+168	Segment 13	Seg.Type	as per segment 1
+ 170		Target SP	
+ 172		Segment time	
+ 174		Ramp rate	
+ 176		Holdback Val	
+ 178		Events	
+ 180		PID	

+ 182	Segment 14	Seg.Type	as per segment 1
+ 184		Target SP	
+ 186		Segment time	
+ 188		Ramp rate	
+ 190		Holdback Val	
+ 192		Events	
+ 194		PID	
+ 196	Segment 15	Seg.Type	as per segment 1
+ 198		Target SP	
+ 200		Segment time	
+ 202		Ramp rate	
+ 204		Holdback Val	
+ 206		Events	
+ 208		PID	

## 14. FTP SERVER

---

The controllers with Ethernet interface have built-in FTP file exchange protocol. The controller works as a server, allowing the clients to access the file system on the SD card inserted in the controller. Access to the files is possible using a computer, a tablet with installed FTP client or other device acting as a FTP client. As standard the port „21” is use to transfer files using FTP protocol. A user can change the port number used by the FTP protocol if necessary. Please note, that the port configuration of the FTP server and the client must be the same. The FTP client program can work in either active or passive mode. It is recommended to set the passive mode, because the connection is fully made by the FTP client (most web browsers use this mode). The client connection in active mode can be blocked by the security systems in the networks and the computers (router, firewall, antivirus). It is possible to use up to one connection at the same time for the file transfer with the controller, so you should limit the maximum number of a FTP client connections to „1”.

### 14.1. FTP User

The controller has one user account for the FTP server with an individual password protection option:

User: „admin”, password: the same as the password to access the controller menu for the user „admin”.

FTP user name cannot be changed while you can change a user password by changing the password to access the controller menu for the user „admin”.

The passwords can be up to 8 characters. If the password is lost, what disables using the FTP server, restore the default settings of Ethernet interface by entering the value of „10” to the register 4000. All standard controller parameters will be restored (except for Ethernet group and the defined programs settings).

The program FileZilla could be an example of the FTP client (Fig. 32). You can view and download the archive files by entering the IP address of the controller in the address field.

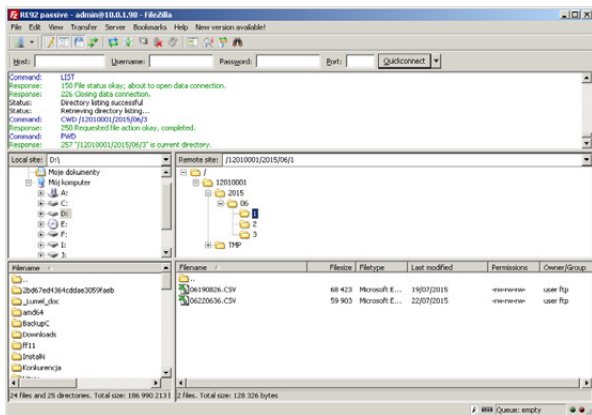

Fig. 32. View of the FTP session in the program FileZilla



## 15. WEB SERVER

---

Access to the Web server is achieved by entering the meter IP address in the web browser, e.g.: <http://192.168.1.030> (where 192.168.1.030 is the set address of the meter). The standard port for web server is port „80“. Server port may be changed by the user.

**Caution:** For proper web page operation a browser with JavaScript enabled and compatible with XHTML 1.0 is required (all popular browsers, Internet Explorer, version 8 minimum).

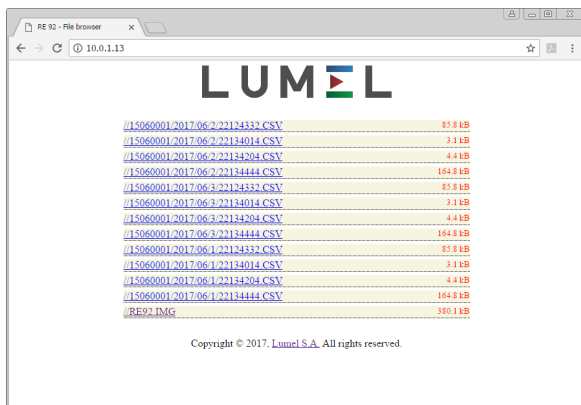

*Fig. 33. An example web server page view*

## 16. SOFTWARE UPGRADE

Controller software may be upgraded. New software versions are available as a one file on the website: [www.lumel.com.pl](http://www.lumel.com.pl).

The correct file name is „RE92.img”. If it is different, please change it to the correct name. After copying this file to the main directory of the SD card, controller software may begin To do this: when controller is off, press and hold left button and then turn a controller supply on.

## 17. TECHNICAL DATA

### Input 1 and 2

Input signals and measuring ranges

Table 25

Sensor type	Standard	Range		Intrinsic error
Pt100	EN 60751:2009	-200...850 °C	-328...1562 °F	0.2%
Pt500		-200...850 °C	-328...1562 °F	0.2%
Pt1000		-200...850 °C	-328...1562 °F	0.2%
Ni100		-60...180 °C	-76...356 °F	0.2%
Ni1000		-60...150 °C	-76...302 °F	0.2%
Cu100		-50...180 °C	-58...356 °F	0.2%
Fe-CuNi (J)	EN 60584-1:1997	-100...1200 °C	-148...2192 °F	0.3%
Cu-CuNi (T)		-100...400 °C	-148...752 °F	0.3%
NiCr-NiAl (K)		-100...1372 °C	-148...2501.6 °F	0.3%
PtRh10-Pt (S)		0...1767 °C	32...3212.6 °F	0.5%
PtRh13-Pt (R)		0...1767 °C	32...3212.6 °F	0.5%
PtRh30-PtRh6 (B)		0...1767 °C <sup>1)</sup>	32...3212.6 °F <sup>1)</sup>	0.5%
NiCr-CuNi (E)		-100...1000 °C	-148...1832 °F	0.3%
NiCrSi-NiSi (N)		-100...1300 °C	-148...2372 °F	0.3%

chromel – kopel (L)	GOST R 8.585-2001	-100...800 °C	-148...1472 °F	0.3%
linear current (I)		0...20 mA	0...20 mA	0.2% ± 1 digit
linear current (I)		4...20 mA	4...20 mA	0.2% ± 1 digit
linear voltage (U)		0...5 V	0...5 V	0.2% ± 1 digit
linear voltage (U)		0...10 V	0...10 V	0.2% ± 1 digit

1) Intrinsic error is related to the measuring range 200...1767 °C  
(392...3212,6 °F)

### Additional errors:

- from automatic compensation  
reference junction temperature  $\leq 2^{\circ}\text{C}$
- from automatic resistance compensation  
of resistance thermometer wires  $\leq 0.3^{\circ}\text{C}$

**Current flowing through  
resistance thermometer sensor** 0.22 mA

**Measurement time** 0.25 s

### Input resistance:

- for voltage input 100 k $\Omega$
- for current input 10  $\Omega$

### Error detection in the measurement circuit:

- thermocouple, Pt100, Pt1000 measuring range exceeded
- 0...10 V over 11 V
- 0...5 V over 5.5 V
- 0...20 mA over 22 mA
- 4...20 mA over 1 mA and over 22 mA

### Input 3 (depends on input 3 in ordering code)

Sensor type	Range	Intrinsic error
linear current	0...20 mA	0.2% ± 1 digit
linear current	4...20 mA	0.2% ± 1 digit
linear voltage	0...5 V	0.2% ± 1 digit
linear voltage	0...10 V	0.2% ± 1 digit
potentiometric 100 Ω	0...100 Ω	0.2% ± 1 digit
potentiometric 1000 Ω	0...1000 Ω	0.2% ± 1 digit

**Measurement time** 0.25 s

#### Input resistance:

- for voltage input 100 kΩ
- for current input 50 Ω

#### Setting range of controller parameters:

see Table 1

#### Binary inputs 1...3

- shorting resistance ≤ 10 kΩ
- opening out resistance ≥ 100 kΩ

#### Output 1 and 2 types:

- relay voltageless NOC contact,  
load capacity 2 A/230 VAC
- voltage transistor 0/5 V, max load capacity  
40 mA

#### Output 3...6 types:

- relay voltageless NOC contact,  
load capacity 2 A/230 VAC

### Analog output types 1A and 2A:

- analog voltage 0...10 V at  $R_{load} \geq 1 \text{ k}\Omega$
- analog current 0...20 mA, 4...20 mA at  $R_{load} \leq 500 \Omega$

### Way of output operation:

- reverse for heating
- direct for cooling

### Analog outputs error

0.5% of the range

### Digital interface

- protocol **RS-485**  
Modbus
- baud rate 4800, 9600, 19200, 38400, 57600, 115200 bit/s
- mode RTU – 8N2, 8E1, 8O1, 8N1
- address 1...247
- maximal response time 500 ms

### Digital interface

- protocol Ethernet  
Modbus TCP slave

### Supply of object transducers

24V d.c.  $\pm 5 \%$ ,  
max.: 30 mA

### Rated operating conditions:

- supply voltage 85...253 V a.c./d.c.
- supply voltage frequency 40...440 Hz
- ambient temperature 0...23...50 °C
- storage temperature -20...+70 °C
- relative air humidity < 85 % (no condensation)
- preheating time 30 min
- operating position any

- resistance of wires connecting the resistance thermometer or thermocouple with controller <math>< 20 \Omega / \text{wire}</math>

**Power input** <math>< 16 \text{ VA}</math>

**Weight** <math>< 0.5 \text{ kg}</math>

**Protection grade ensured by the housing**

acc. to EN 60529

- from the frontal plate IP65
- from the terminal side IP20

**Additional errors in rated operating conditions caused by:**

- ambient temperature change  $\leq 100 \%$  intrinsic error value /10 K.

**Safety requirements acc. to EN 61010-1**

- installation category III,
- pollution level 2,
- maximum phase-to-earth operating voltage:
  - for supply circuit, output 300 V
  - for input circuits 50 V
- altitude a.s.l. <math>< 2000 \text{ m}</math>

**Electromagnetic compatibility:**

- noise immunity, acc. to standard EN 61000-6-2
- noise emission, acc. to standard EN 61000-6-4

# 18. CONTROLLER ORDERING CODE

Versions and ordering

Table 26

	RE92	X	X	X	X	X	XX	X	X
<b>Input 3:</b>									
none		0							
current: 0/4...20 mA		1							
voltage: 0...5/10 V		2							
potentiometric transmitter: 100/ 1000 Ω		3							
<b>Output 1 and 2:</b>									
2 relays		1							
2 binary outputs 0/5 V		2							
<b>Analog outputs:</b>									
none						0			
2 analog outputs 0/4...20 mA and 0...10 V						1			
<b>Ethernet:</b>									
none								0	
with Ethernet									1
<b>Transducer supply:</b>									
none								0	
24 V d.c.									1
<b>Version:</b>									
standard								00	
custom-made*									XX
<b>Language:</b>									
Polish-English									M
other*									X
<b>Additional quality requirements:</b>									
without additional quality requirements									0
with extra quality inspection certificate									1
with calibration certificate									2
acc. to customer's request									X

\* - only after agreeing with a manufacturer

**IN STANDARD:** 2 universal inputs; 3 binary inputs; 6 relays; RS-485 Modbus Slave; supply 85...253 V a.c./d.c



**LUMEL S.A.**

ul. Sulechowska, 65-022 Zielona Góra, POLAND

tel.: +48 68 45 75 100

[www.lumel.com.pl](http://www.lumel.com.pl)

**Export department:**

tel.: (+48 68) 45 75 139, 45 75 233, 45 75 321, 45 75 386

fax.: (+48 68) 32 54 091

e-mail: [export@lumel.com.pl](mailto:export@lumel.com.pl)